

LIFTING CAPACITIES

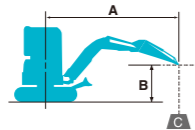

Rating over front

Rating over side or 360 degrees

A: Reach from swing centerline to arm top
 B: Arm top height above/below ground
 C: Lifting capacities in kilograms
 Bucket: Without bucket Dozer blade: up
 Relief valve setting: 23.0 MPa

SK28SR Cab		Arm: 1.18 m, Bucket: without Shoe: 300 mm										
		1.0 m		2.0 m		3.0 m		4.0 m		At Max. Reach		Radius
B	A											
3.0 m	kg			*1,150	890	*630	490			510	370	3.51 m
2.0 m	kg					640	470	400	290	400	290	4.00 m
1.0 m	kg					600	430	390	280	370	260	4.12 m
G. L.	kg			1,110	730	570	400			390	280	3.92 m
-1.0 m	kg	*2,090	*2,090	1,130	750	580	410			500	350	3.32 m

SK28SR Canopy		Arm: 1.18 m, Bucket: without Shoe: 300 mm										
		1.0 m		2.0 m		3.0 m		4.0 m		At Max. Reach		Radius
B	A											
3.0 m	kg					*630	470			480	350	3.51 m
2.0 m	kg			*1,150	850	610	440	370	270	370	270	4.00 m
1.0 m	kg					560	400	360	260	340	250	4.12 m
G. L.	kg			1,040	690	540	380			360	260	3.92 m
-1.0 m	kg	*2,090	*2,090	1,050	700	540	380			470	330	3.32 m

SK30SR Cab		Arm: 1.32 m, Bucket: without Shoe: 300 mm										
		1.0 m		2.0 m		3.0 m		4.0 m		At Max. Reach		Radius
B	A											
4.0 m	kg					780	620			740	590	3.08 m
3.0 m	kg									480	380	3.97 m
2.0 m	kg					740	580	460	370	400	310	4.38 m
1.0 m	kg					680	530	440	350	370	290	4.48 m
G. L.	kg			1,250	910	650	500	430	330	390	300	4.29 m
-1.0 m	kg	*2,050	*2,050	1,270	930	650	500			470	370	3.77 m
-2.0 m	kg			*970	*970					*640	*640	2.60 m

SK30SR Canopy		Arm: 1.32 m, Bucket: without Shoe: 300 mm										
		1.0 m		2.0 m		3.0 m		4.0 m		At Max. Reach		Radius
B	A											
4.0 m	kg					740	590			700	560	3.08 m
3.0 m	kg									450	360	3.97 m
2.0 m	kg					700	550	440	350	370	300	4.38 m
1.0 m	kg					640	500	420	330	350	270	4.48 m
G. L.	kg			1,180	860	610	470	400	320	370	290	4.29 m
-1.0 m	kg	*2,050	*2,050	1,200	880	610	470			450	350	3.77 m
-2.0 m	kg			*970	930					*640	620	2.60 m

SK35SR Cab		Arm: 1.37 m, Bucket: without Shoe: 300 mm										
		1.0 m		2.0 m		3.0 m		4.0 m		At Max. Reach		Radius
B	A											
4.0 m	kg									800	750	3.32 m
3.0 m	kg							590	550	550	520	4.15 m
2.0 m	kg					900	840	570	540	470	440	4.54 m
1.0 m	kg					830	780	550	520	440	420	4.63 m
G. L.	kg			1,530	1,390	800	740	530	500	460	430	4.45 m
-1.0 m	kg	*2,290	*2,290	1,550	1,400	800	740			550	510	3.95 m
-2.0 m	kg			*1,550	1,460					880	820	2.90 m

SK35SR Canopy		Arm: 1.37 m, Bucket: without Shoe: 300 mm										
		1.0 m		2.0 m		3.0 m		4.0 m		At Max. Reach		Radius
B	A											
4.0 m	kg									770	720	3.32 m
3.0 m	kg							560	530	530	500	4.15 m
2.0 m	kg					860	810	550	520	450	420	4.54 m
1.0 m	kg					800	740	520	490	420	400	4.63 m
G. L.	kg			1,460	1,330	760	710	510	480	440	410	4.45 m
-1.0 m	kg	*2,290	*2,290	1,480	1,350	760	710			520	490	3.95 m
-2.0 m	kg			1,540	1,400					840	790	2.90 m

- Notes:**
- Do not attempt to lift or hold any load that is greater than these lift capacities at their specified lift point radius and heights. Weight of all accessories must be deducted from the above lift capacities.
 - Lift capacities are based on machine standing on level, firm, and uniform ground. User must make allowance for job conditions such as soft or uneven ground, out of level conditions, side loads, sudden stopping of loads, hazardous conditions, experience of personnel, etc.
 - Arm top defined as lift point.
 - The above lifting capacities are in compliance with ISO 10567. They do not exceed 87% of hydraulic lifting capacity or 75% of tipping load. Lifting capacities marked with an asterisk (*) are limited by hydraulic capacity rather than tipping load.
 - Operator should be fully acquainted with the Operator's and Maintenance Instructions before operating this machine. Rules for safe operation of equipment should be adhered to at all times.
 - Lift capacities apply to only machine as originally manufactured and normally equipped by KOBELCO CONSTRUCTION MACHINERY CO., LTD.

Note: This catalog may contain attachments and optional equipment that are not available in your area. And it may contain photographs of machines with specifications that differ from those of machines sold in your areas. Please consult your nearest KOBELCO distributor for those items you require. Due to our policy of continuous product improvements all designs and specifications are subject to change without advance notice. Copyright by KOBELCO CONSTRUCTION MACHINERY CO., LTD. No part of this catalog may be reproduced in any manner without notice.

KOBELCO CONSTRUCTION MACHINERY CO., LTD.

17-1, Higashigotanda 2-chome, Shinagawa-ku, Tokyo 141-8626 JAPAN
 Tel: +81 (0) 3-5789-2146 Fax: +81 (0) 3-5789-2135
 www.kobelco-kenki.co.jp/english_index.html

Inquiries To:

SK28SR/SK30SR/SK35SR-ANZ-101-140603 IF

KOBELCO

SK28SR-6/SK30SR-6/SK35SR-6

MINI EXCAVATORS

SK28SR SK30SR SK35SR



We Save You Fuel
 Achieving a Low-Carbon Society

Full-Size Performance, Short-Radius Agility and Quiet Operation

COMPACT YET TOUGH MINI

The new KOBELCO SK28SR, SK30SR and SK35SR expand the horizons of mini excavators, and offer practical performance features while maintaining a short tail swing. The new Energy Conservation Mode saves even more fuel, and Kobelco's proprietary iNDR Cooling System ensures quiet operation, protection from dust, and easy maintenance. For greater operator comfort and safety, the spacious cab design offers plenty of room and an unobstructed view. It all adds up to enhanced full-size performance, short-radius agility and a low-noise environment, with exceptional performance features and a full range of value-added functions.

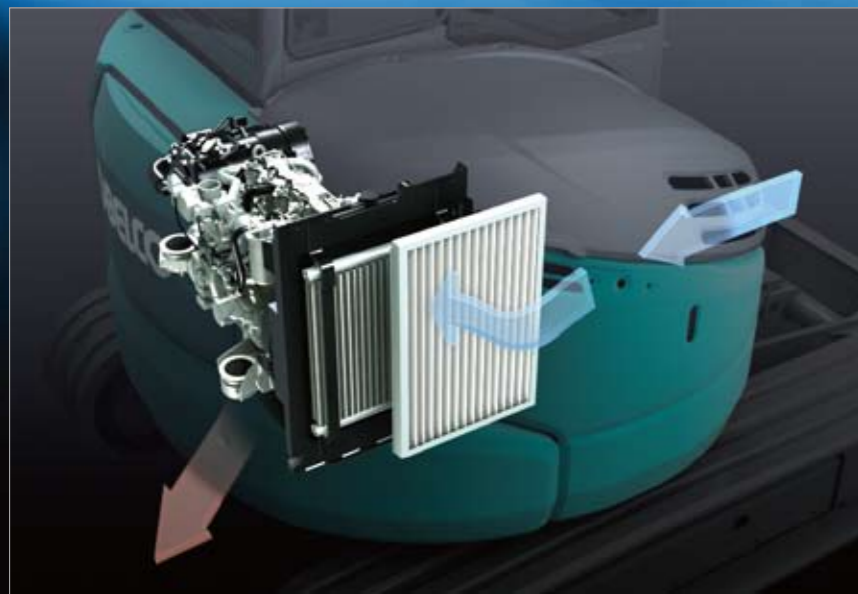

ENVIRONMENT

iNDr Cooling System

The Revolutionary Integrated Noise and Dust Reduction Cooling System



The highly airtight engine compartment and the offset duct contribute to noise reduction. The iNDr filter fitted in front of the cooling system ensures easy cleaning. The iNDr system on the SR Series mini excavators features air intake at the front of the machine and air exhaust underneath. It functions in the same way as the iNDr System on the SR series machines.

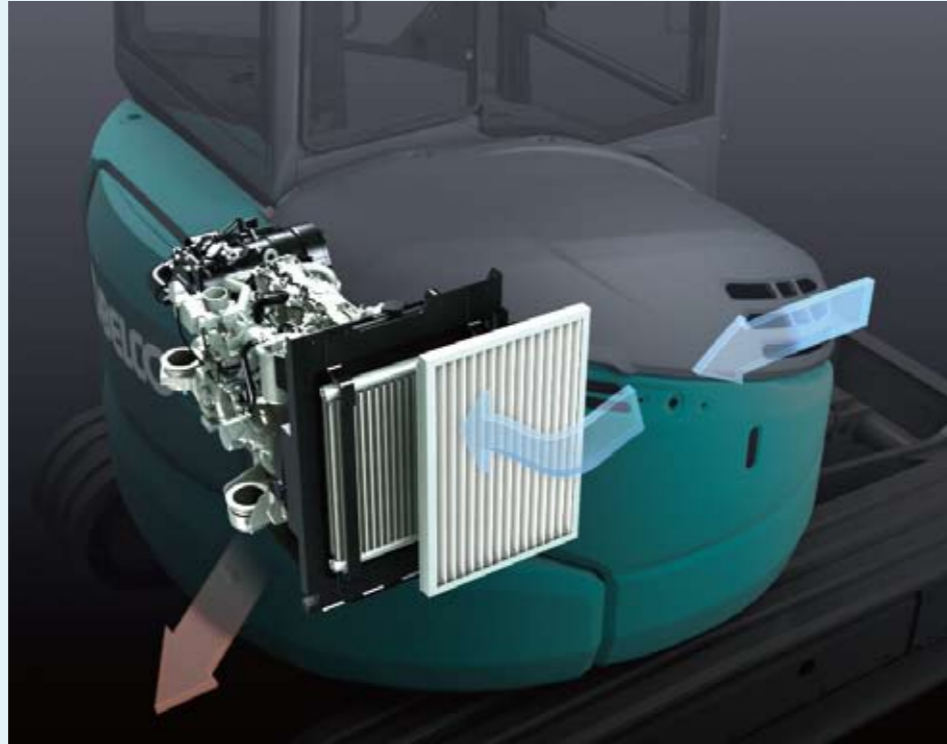

Visual Checking and Easy Cleaning

Because the iNDr filter removes dust from the intake air, cooling components stay dirt-free and do not require regular cleaning. The iNDr filter itself can be easily removed and cleaned without the use of tools.



iNDr Filter

The stainless-steel filter is extremely effective against dust, with 30-mesh wave-type screen that removes tiny dust particles from the intake air.

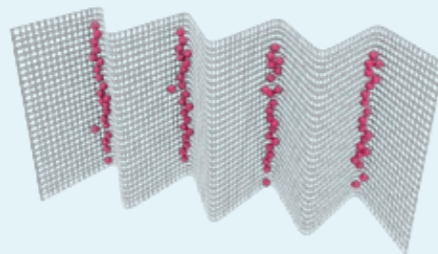

•30-mesh means that there are 30 holes formed by horizontal and vertical wires in every square inch of filter.

iNDr Filter Blocks Out Dust

Outside air goes directly from the intake duct through the iNDr filter for dust removal.



Ultimate Low Noise

KOBELCO's exclusive iNDr Cooling System delivers amazingly quiet operation.



at 1 m backward from machine rearend and 1.5 m height from ground level.

PERFORMANCE

Compact, yet, Big Performance

Wide Working Range

A larger boom and arm are provided as standard equipment to ensure a wider working range.

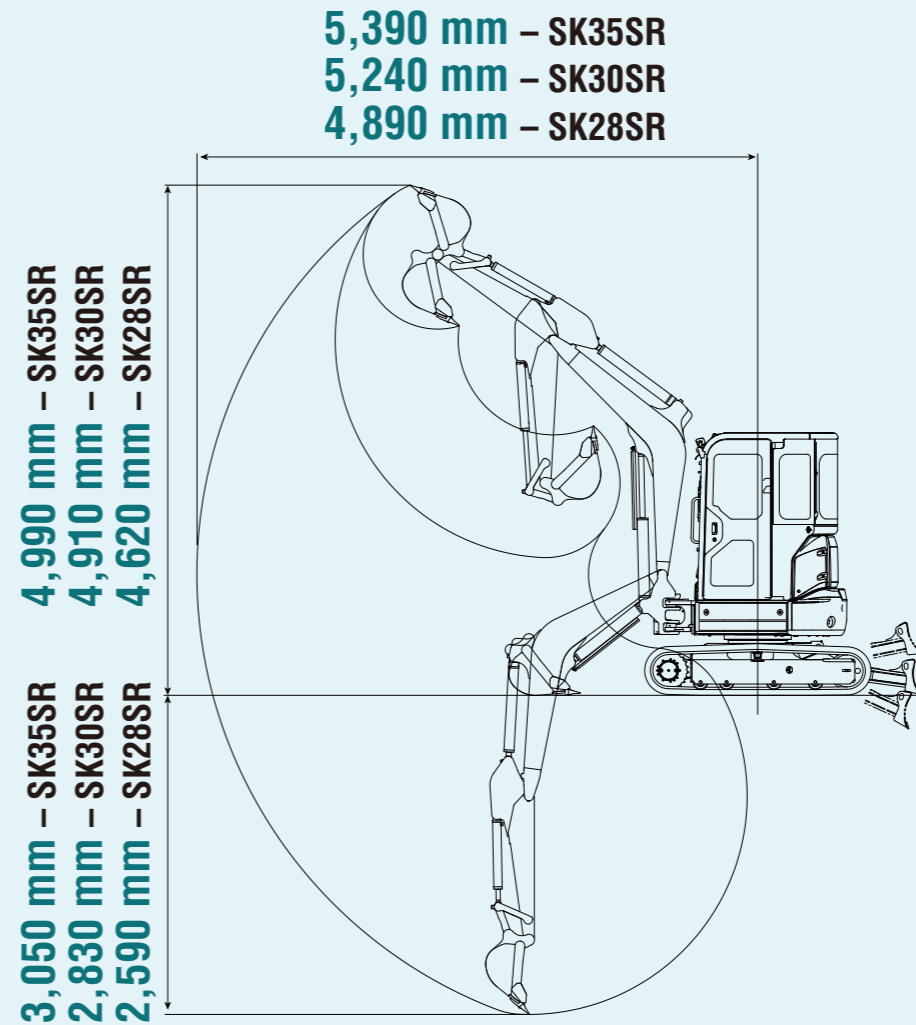

Short Tail Swing

The compact tail swing improves operating efficiency in limited space.



Easy Transportability

With an overall height of 2,510 mm, the machine is designed for easy transport.



Easy Hydraulic Piping for Quick Hitch

Piping for Quick Hitch is fitted as standard.

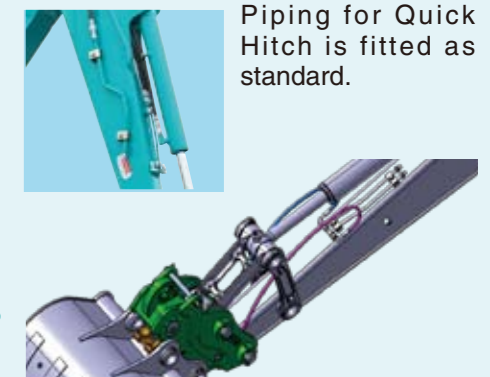

PERFORMANCE

Fuel Economy and Digging Power

Solid Digging Performance

Assured Pump Flow and Pump Pressure

Pump flow of 38.4 L/min for SK30SR and SK35SR and 28.8 L/min for SK28SR, and pressure of 23.0 MPa (relief valve setting), maintain ample power.

Integrated-Flow Pump System

The instant the machine begins to dig, extra output from the third pump (which otherwise powers the swing and dozer circuit) is directed to the arm circuit and boom circuit (raise) for added power. This ensures fast and smooth arm and boom raising operation even under heavy loads.

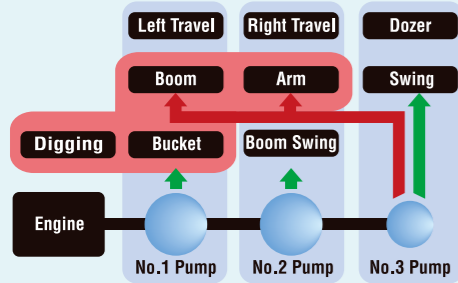

Energy Conservation Mode

SK28SR, SK30SR and SK35SR equipped with S mode, which lowers fuel consumption by up to 25% over previous models.



One Touch Deceleration

The machine features one-touch deceleration. It allows easy switching to an idling state, reducing the fuel consumption while the machine is at rest.



Travel Power

Large Capacity Travel Torque

The large capacity travel torque enables the machine to perform spin turn in low mode even when the dozer is pushing a heavy load.

Automatic Two-Speed Travel

An automatic shift function ensures smoother, more efficient travel on worksite. When the High mode is selected, the travel system will automatically shift to Low mode whenever the load or climbing grades requires more power.

Travel Switch

The travel lever is fitted with a button for easy switching to H-Mode travel.



Powerful and Efficient Dozer Performance

Dozer-Blade Shape

KOBELCO's unique blade design solves this problem by forming the earth into an arc that always falls forward. Because this prevents earth from falling behind the blade, only "one pass" is needed.



Hydraulic Pilot-Controlled Dozer Operation Lever



The dozer lever features hydraulic pilot control for precise handling.

MAINTENANCE

Easy Daily Maintenance

Start-up checks are essential for safe and reliable machine operation. All start-up checks can be performed at ground level, with an easy-to-understand layout and cover design that simplify access and save time.

Easy Access to Component Under the Seat



Two-piece floor mats for easy washing



Hour meter



Easy Access to Cooling Unit

iNDR filter



Fuel tank

Easy Access to Engine Compartment

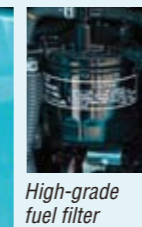

High-grade fuel filter



Pre fuel filter with built-in water separator



Air cleaner

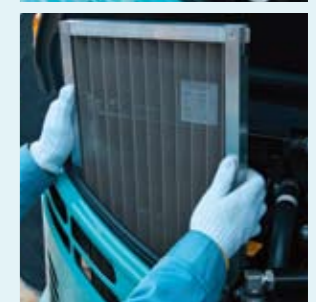

COMFORT

Comfortable Work Environment

Spacious Work Environment

The spacious cab provides optimized control layout for comfortable, easy operation. A greater window area further improves visibility. A clear view is provided at the rear, and there's also more floor space, with a seat that slides further to ensure plenty of leg room.



Seat in photo shows Australian spec.



Seat in photo shows U.S. spec.

Easy Access

A wide-opening door and a left-hand tilting control console with safety lever that rises high, make it easy for operators to enter and exit the cab.



Work Light



Work light is mounted under the boom to protect from damage.

Skylight



Control Lever

Precise proportional controls (optional) are integrated into the joystick for ease of operation.



Pattern Changer

Pattern changer allows for increased utilization and flexibility to match operator preference.

*Pattern Changer is standard fitting for Australia.
Another pattern changer is provided for New Zealand.*



Color Liquid Crystal Monitor

The color liquid crystal monitor is fitted as standard. Operation data as well as the full range of machine-status data can readily be checked.



Maintenance

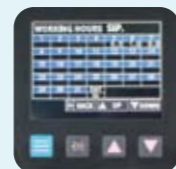

Working hours

Comfortable Operating Environment

Hammer for emergency exit



Climate control

The climate control system is located down and to the right of the seat keeping the rear view clear.



Vents to send cooled air toward the operator if he desires.



Seat in photo shows U.S. spec.

Opening/closing front window

The front window features gas damper cylinders for smooth and easy opening and closing.



Coat hook



Room light

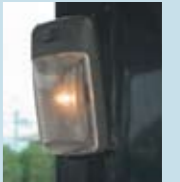

Two-speaker FM/AM radio with station select (optional)



Operator Safety

Reliable Cab/Canopy Structure

The high-strength cab/canopy meets ROPS and TOP GUARD LEVEL 1 standards for greater operator safety.



RELIABILITY

Reliable Construction

The boom, arm and swing bracket all have large cross-section segments for added attachment strength.

Strong boom and arm

Bolt-tightened pins firmly lock the boom and arm to prevent the boom top from opening laterally.



Forged boom top



Plate type pin

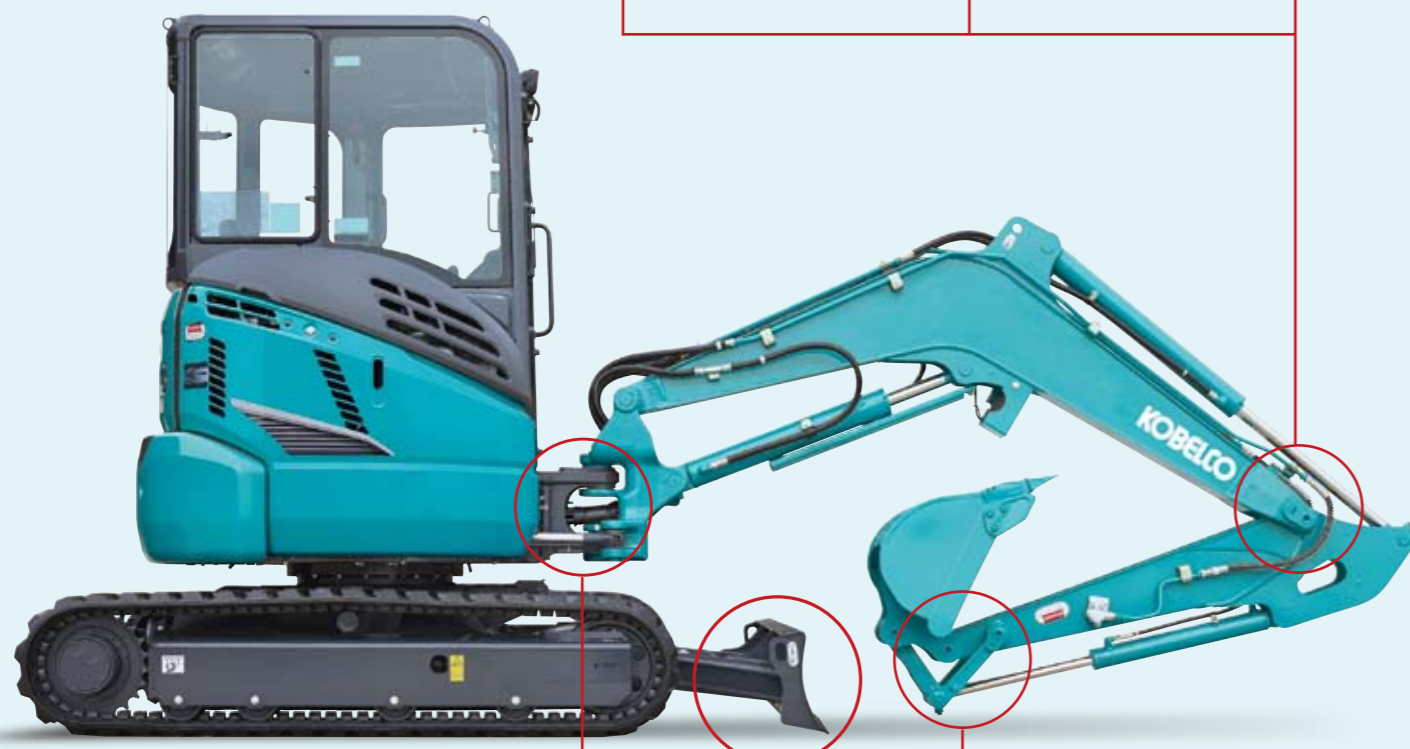

Swing bracket

Large, thick cast-iron swing bracket/front bracket.



Hydraulic piping

The hydraulic piping is housed inside the swing bracket.



Dozer

Box construction dozer supports provide greater strength.

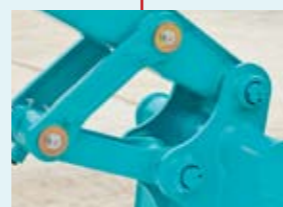

Bucket

Cast-iron idler link provide greater strength.

SPECIFICATIONS

MODEL		SK28SR	SK30SR	SK35SR
Type		SK28SR-6	SK30SR-6	SK35SR-6
Machine Mass	Cab	kg	2,950	3,380
	Canopy	kg	2,790	3,220
Bucket Capacity		m ³	0.08	0.09
Bucket Width (with side cutter)		mm	500	500
Arm Length		m	1.18	1.32
Bucket Digging Force		kN	24.7	27.7
Arm Crowding Force		kN	16.6	19.1
ENGINE				
Model		YANMAR 3TNV82A-B		
Type		Water cooled, 4-cycle, 3-cylinder, direct injection, diesel engine		
Power Output	(ISO 9249)	kW/min ⁻¹	17.1/2,400	
	(ISO 14396)	kW/min ⁻¹	18.1/2,400	
Max. Torque	(ISO 9249)	N-m/min ⁻¹	77.7/1,440	
	(ISO 14396)	N-m/min ⁻¹	79.4/1,440	
Displacement		L	1.331	
Fuel Tank		L	42	
HYDRAULIC SYSTEM				
Pump		Two variable displacement pumps + One gear pump		
Max. Discharge Flow		L/min	2 x 28.8, 1 x 16.1	2 x 38.4, 1 x 19.2
Relief Valve Setting		MPa	23.0	
Hydraulic Oil Tank (system)		L	20.4 (41.1)	20.4 (44.8)
TRAVEL SYSTEM				
Travel Motors		2 x axial-piston, two-step motors		
Parking Brake		Oil disc brake per motor		
Travel Speed (high/low)		km/h	3.8/2.1	4.4/2.5
Gradeability		% (degree)	58 (30)	
Drawbar Pulling Force	Cab	kN	34.8	38.3
	Canopy	kN	34.9	38.4
CRAWLER				
Shoe		mm	Rubber	
Shoe Width		mm	300	
Ground Pressure	Cab	kPa	26.3	30.1
	Canopy	kPa	24.9	28.7
DOZER BLADE				
Width x Height		mm	1,550 x 345	1,550 x 345
Working Ranges (height/depth)		mm	375/300	395/320
SWING SYSTEM				
Swing Motor		Axial piston motor		
Parking Brake		Oil disc brake, hydraulic operated automatically		
Swing Speed		min ⁻¹	8.4	
Tail Swing Radius		mm	775	850
Min. Front Swing Radius	Over the front	mm	2,330	2,430
	At full boom swing	mm	2,040	2,030
SIDE DIGGING MECHANISM				
Type		Boom swing		
Offset Angle	to the left	degree	60	70
	to the right	degree	55	60

WORKING RANGES

Unit: mm

MODEL	SK28SR	SK30SR	SK35SR
Arm length	1.18 m	1.32 m	1.37 m
a- Max. digging reach	4,890	5,240	5,390
b- Max. digging reach at ground level	4,730	5,080	5,240
c- Max. digging depth	2,590	2,830	3,050
d- Max. digging height	4,620	4,910	4,990
e- Max. dumping clearance	3,210	3,510	3,600
f- Min. dumping clearance	1,330	1,320	1,330
g- Max. vertical wall digging depth	2,410	2,510	2,620
h- Min. swing radius	2,330	2,430	2,380
i- Horizontal digging stroke at ground level	1,810	2,140	2,320
j- Dozer blade (height/depth)	375/300	395/320	395/320

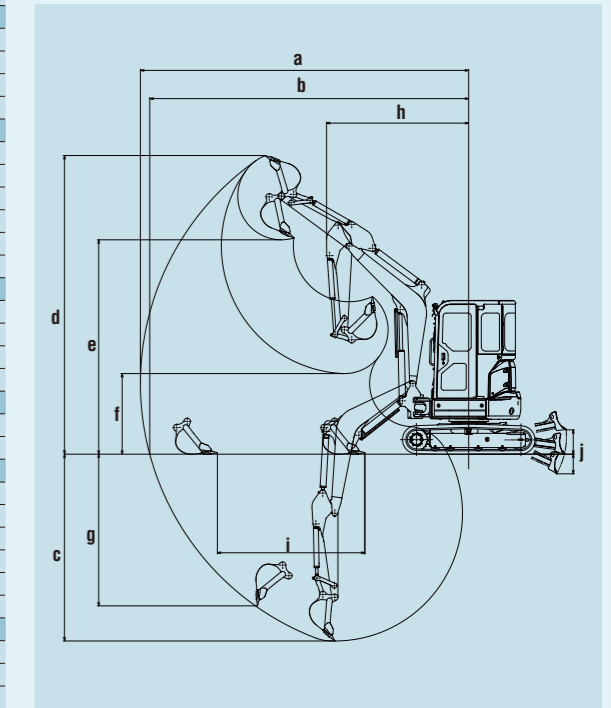

GENERAL DIMENSIONS

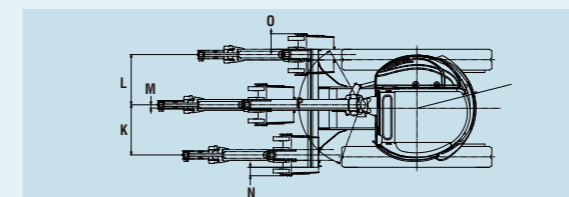
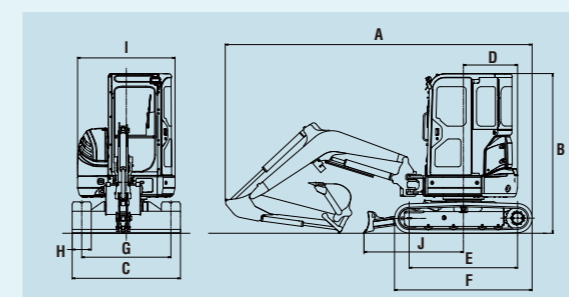

MODEL	SK28SR	SK30SR	SK35SR
A Overall length	4,550	4,760	4,870
B Overall height	2,510	2,510	2,510
C Overall width	1,550	1,550	1,700
D Tail swing radius	775	775	850
E Tumbler distance	1,700	1,700	1,700
F Overall length of crawler	2,160	2,160	2,160
G Track gauge	1,250	1,250	1,400
H Shoe width	300	300	300
I Overall width of upperstructure	1,530	1,530	1,530
J Distance from dozer top to center of upperstructure	1,500	1,560	1,560

MODEL	SK28SR	SK30SR	SK35SR
K	680	720	720
L	675	725	725
M	50	50	50
N	100	150	120
O	200	250	225
P	60°/55°	70°/60°	70°/60°

OPTIONAL EQUIPMENT

- N&B (HCP*) piping
- N&B (foot) piping + Rotating N&B (HCP*)
- N&B (HCP*) piping + Rotating N&B (HCP*)
- ROPS cab with air conditioner
- Radio (only for cab)
- Steel shoe
- Bolt-on Pad shoes (for steel shoes)
- Add-on counterweight (250 kg) + 90 mm tail swing radius
- Boom & arm holding valve
- Wide range of buckets
- Rear view mirror
- Rear under mirror
- BHL lever
- Multi-control valve
- Arm & bucket cylinder cover
- Front guard
- 12 V power source

*Hand Control Proportional