



Note: This catalog may contain attachments and optional equipment that are not available in your area. And it may contain photographs of machines with specifications that differ from those of machines sold in your areas. Please consult your nearest KOBELCO distributor for those items you require. Due to our policy of continuous product improvements all designs and specifications are subject to change without advance notice. Copyright by **KOBELCO CONSTRUCTION MACHINERY CO., LTD.** No part of this catalog may be reproduced in any manner without notice.

**KOBELCO CONSTRUCTION MACHINERY CO., LTD.**

5-15, Kitashinagawa 5-chome, Shinagawa-ku, Tokyo 141-8626 JAPAN  
Tel: +81 (0) 3-5789-2146 Fax: +81 (0) 3-5789-2135  
[www.kobelco-kenki.co.jp/english\\_index.html](http://www.kobelco-kenki.co.jp/english_index.html)

Inquiries To:

Bulletin No. SK135SR/SK140SR<sub>LC</sub>-5-ANZ-101

# Power Meets Efficiency

With iNDR for even quieter operation.

"KOBELCO has made the short rear swing excavator the standard for mid-sized machines. And with ongoing development in innovations such as the iNDR noise reduction system that both shuts out dust and cuts noise, KOBELCO is boosting value and leading the industry with construction machinery ideally suited to the urban environment.

The new SK135SR/SK140SR<sub>LC</sub> retains the compact shape and iNDR system advantages that KOBELCO has pioneered, but it has been fitted with a new and larger engine assembly for improved environmental protection. Low fuel consumption is balanced against work performance, and machine durability has been advanced.

The new worldwide-model SK135SR/SK140SR<sub>LC</sub>. Working for the planet."



**SK135SR SK140SR<sub>LC</sub>**

# Low Noise and Easy Maintenance Mean Greater Value Than Ever A New Design Approach Leads to a Revolutionary Double Offset Duct Structure

By reviewing the iNDR configuration, Kobelco achieved both great visibility and a compelling design even though the engine compartment has been enlarged to meet Stage IV standards, maintaining the value of iNDR.

iNDR absorbs sound energy to minimize noise by making a path of air, which cools down engine, as one engine cooling ducts. The new model is equipped with a selective catalytic reduction (SCR) unit, which required a new design with two offset ducts on top. This allows ample space to absorb engine noise, making these new excavators as quiet as conventional models.

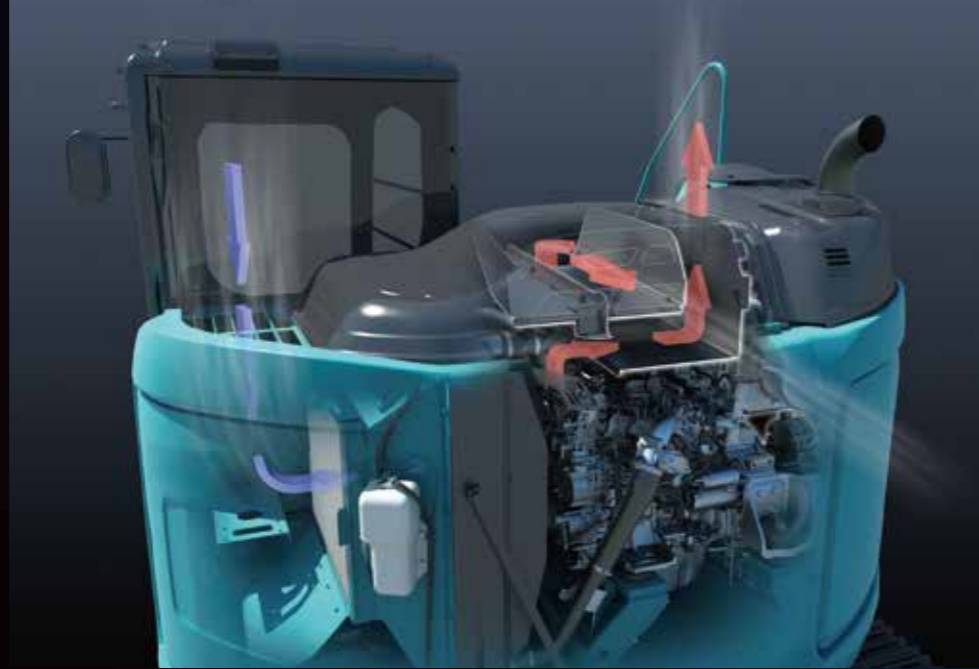

## Wide, clear view to the rear

Even with the larger engine compartment, the design minimizes hood height, ensuring an excellent direct view to the rear. In addition, the operator can monitor conditions behind the machine with clear, wide-angle images from the rear-view camera, which comes as standard equipment.



## The Results Are Exceptional. The Big Merits:

### "Ultimate Low Noise" is achieved by minimizing sound leakage during operation

Kobelco's "Ultimate Low Noise" system exceeds all noise standards. Noise from the engine and cooling fan is absorbed by the duct, reducing machine's noise signature to the lowest in the industry. Perfect for urban utility renewal projects.



### Eliminating dust maintains cooling system performance

The high-density 60-mesh filter\* blocks out dust in the intake air. This prevents clogging of the cooling system and the air cleaner, which maintains peak performance. The waveform filter allows air through the tops of the waves while collecting dust at the bottom, ensuring a smooth airflow.

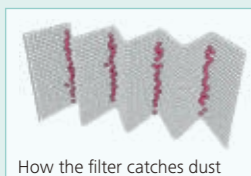

\* "60-mesh" means that there are 60 holes formed by horizontal and vertical wires in every square inch of filter.

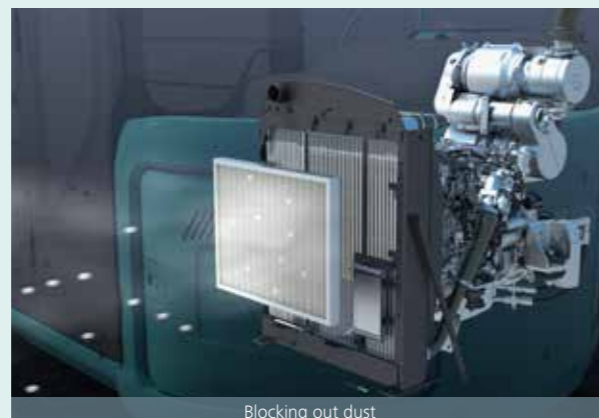

### Easy filter maintenance system simplifies cleaning

Daily inspection consists of a visual check of the iNDR filter only. If it looks dirty, it can be removed and washed without special tools.



## NOx emissions cut: New, Environmentally Friendly Engine

### New Stage IV compliance engine **NEW**

The new type of Stage IV compliant engine is fitted with a diesel oxidation catalyst (DOC) and an SCR device to control emissions without using a diesel particulate filter (DPF). It has a large-capacity Urea tank, extending intervals between fill-ups.

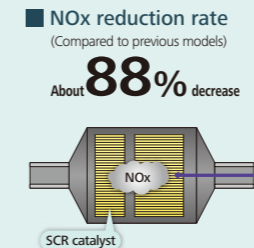

### A newly developed engine raises the bar for construction machinery

The latest Kobelco SK135SR/SK140SRLC uses an ISUZU engine that is renowned for environmental performance, and has been tuned specifically for use in Kobelco machines. This new, environmentally friendly engine changes conventional wisdom on balancing powerful performance with eco-friendliness. Eliminating the DPF makes maintenance faster and easier than ever.

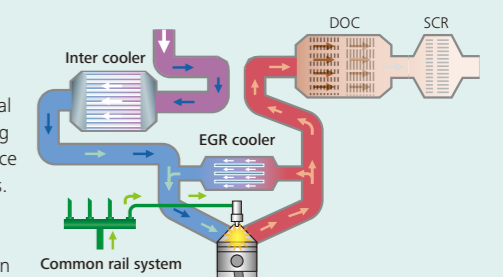

At high temperatures, nitrogen and oxygen combine to produce nitrous oxides (NOx). Reducing the amount of oxygen and lowering the combustion temperature results in much less NOx.

### EGR cooler

While ensuring sufficient oxygen for combustion, cooled emission gases are mixed with the intake air and recirculated into the engine. This reduces oxygen content and lowers combustion temperature.

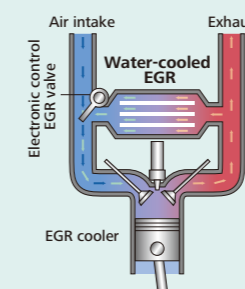

Particulate matter (PM) is mostly soot resulting from incomplete combustion; Improved combustion efficiency reduces PM emissions. filter further reduces PM emissions.

### Common rail system

High-pressure injection atomizes the fuel, and more precise injection improves combustion efficiency. This also contributes to better fuel economy.

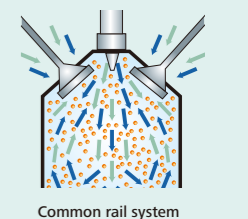

# Unbeatable Cost Performance

Great Fuel Efficiency:  
Exceeding Expectations in Productivity

## Great Fuel Efficiency Contributes to High Performance

### Superior Digging Volume

This excavator offers dynamic digging force even as it minimizes fuel consumption rates, achieving class-leading work volume.

■ Max. bucket digging force

**90.1kN (ISO 6015)**

■ Max. arm crowding force

**64.4kN (ISO 6015)**



## In Pursuit of Improved Fuel Efficiency

### Operation Mode

Fuel consumption is lower in H-mode/S-mode/ECO-mode in comparison with the previous model. (SK135SR-2)

■ Compared to previous models

- H** H-mode  
... About **8%** improvement
- S** S-mode  
... About **16%** improvement
- E** ECO-mode  
... About **21%** improvement

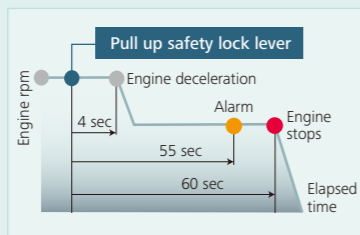

### AIS (Auto Idle Stop)

If the boarding/disembarking lever is left up, the engine will stop automatically. This eliminates wasteful idling during standby, saving fuel and reducing CO<sub>2</sub> emissions as well.

### Hydraulic system engineered to reduce energy loss

Kobelco's proprietary hydraulic systems offer hydraulic line positioning that reduces friction resistance and valves designed for higher efficiency, minimizing energy loss throughout the system.

### Always and forever. Yesterday, today, and tomorrow. We're obsessed with fuel efficiency

Over the past 8 years, KOBELCO has achieved an average fuel consumption reduction of 21% across its fleet. We vow to lead the industry in improving fuel efficiency.

■ Compared to SK135SR-2 (2008)

**E** ECO-mode (SK135SR-5) ... About **21%** improvement

## Ideal for Urban Work Sites Provides a Broad Working Range, Even in Close Quarters

### Minimal swing radius improves efficiency

The tail of the upper body extends very little past the crawlers, so the operator can concentrate on the job at hand. This also reduces the risk of collision damage.

### Easy workability in less than 3,500mm of space

The compact design allows continuous 180° dig, swing, and load operations within a working space of just 3.49m.

\*Tail swing radius of SK140SR-2 with dozer and additional counter weight is 1,600mm.

### Seamless feeling, smooth combined operations

The machines have inherited the various systems that make inching and combined operations easy and accurate. Leveling and other combined operations can be carried out with graceful ease.

### Swing operation cuts cycle times

Fast cycle times as a result of fast swing and boom operations.

### Strong drawbar pulling force produces powerful travel capabilities

These new excavators handle steep slopes and rough roads with ease while ensuring smooth changes in direction.

### Drawbar pulling force: 138kN

### Excellent working ranges

Greater working ranges with class-topping vertical digging depth.

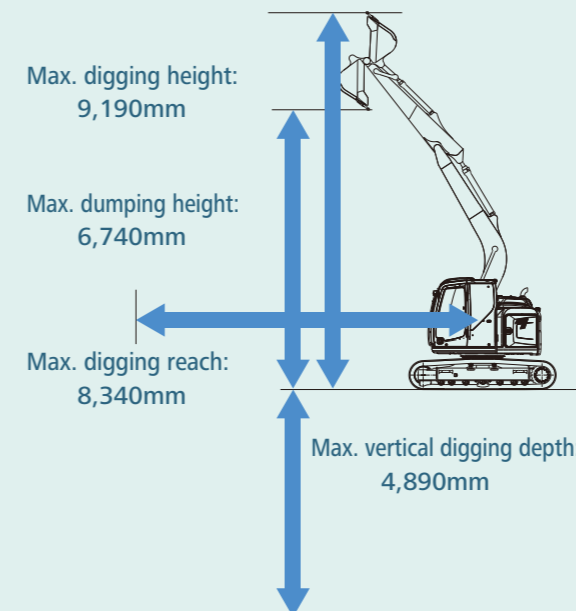

### Easy hydraulic piping for quick hitch

A quick hitch hydraulic line, which speeds up attachment changes, is available as standard.



# Comprehensive safety and intuitive operation

User-friendly design and enhanced safety means greater efficiency and productivity.



## Safety

### ROPS cab

ROPS (Roll-Over-Protective Structure)-compliant cab clears ISO standards (ISO-12117-2: 2008) and ensures greater safety for the operator should the machine tip over.



Top Guard level II (Meets ISO10262)



Mounting brackets for vandalism guards are standard equipment (contact your KOBELCO dealer to fit vandalism).

### Expanded field of view for greater safety



Left and right rear-view mirrors/Right bottom clearance mirror



Rear view from cab



Rear-view camera

Rear

### Optional right side camera NEW



Emergency escape hammer



Right-side camera

Monitor

Rear

Right

## Operator-friendly Features Include Controls that Are Easy to See, Easy to Use



### Multi-Display in color

Brilliant colors and graphic displays are easy to recognize on the LCD multi-display in the console. The display shows fuel consumption, maintenance intervals, and more.

- 1 Analog gauge provides an intuitive reading of fuel level and engine water temperature
- 2 Green indicator light shows low fuel consumption during operation
- 3 Urea level gauge
- 4 Fuel consumption/Switch indicator for rear camera images
- 5 Digging mode switch
- 6 Monitor display switch

### One-touch attachment mode switch

A simple flick of a switch converts the hydraulic circuit and flow amount to match attachment changes. Icons help the operator to confirm the proper configuration at a glance.

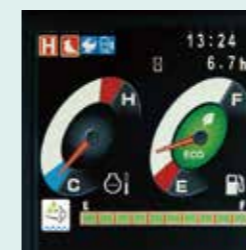

PM accumulation display (left)/ Urea level gauge (right)

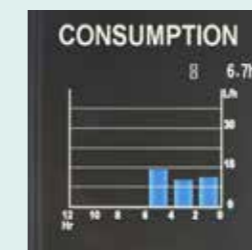

Fuel consumption



Maintenance

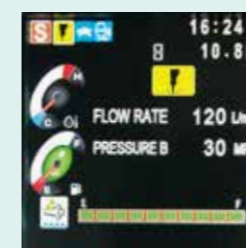

Breaker mode

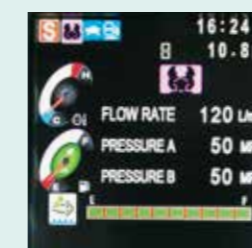

Nibbler mode

# Cab Design That Puts the Operator First

Wide and open, the cab's interior overflows with features that streamline operation



## Comfort

### Big roomy cab

The cubic design makes the most of straight lines, so the cab interior is 4% more spacious than before. Operating space literally spreads out before the operator. And the 50Pa airtightness keeps dust outside.

### A Light Touch on the Lever Means Smoother, Less Tiring Work NEW

It takes 38% less effort to work the operation lever, which reduces fatigue over long working hours or continued operations.



### Wide-open field of view

On the right side, the large single window has no center pillar, and the whole cab is designed for a wide field of view, giving the operator a direct view ahead and to the left and right. Mirror makes it easy for the operator to make sure things are safe all around.

### Wide doors and ample head clearance mean smooth entry and exit

The control box and safety lock lever tilt up at a larger angle, and the door handle height is positioned for easy cab entry and exit.



### More comfortable seat means higher productivity

The cab interior offers a host of operator comforts. The seat guarantees comfort whether on the job or at rest, and everything is ergonomically planned and laid out for smooth, stress-free operation.



Seat suspension absorbs vibration



Seat recliner can be greatly tilted



Double slides allow adjustment for optimum comfort

## Equipment designed for comfort and convenience



### Bluetooth installed NEW radio

Bluetooth installed to allow connections with audio devices.



### Powerful automatic air conditioner

Also standard is an automatic air conditioner that maintains a comfortable interior environment all year around.



Spacious storage tray



Large cup holder



USB/AUX



12V power outlet

# Proper Maintenance Ensures Peak Efficiency

Kobelco machines are designed for quick, simple inspection and maintenance.



## Machine Information Display Function

- Displays only the maintenance information that's needed, when it's needed
- Self-diagnostic function provides early-warning detection and display of electrical system malfunctions
- Service-diagnostic function makes it easier to check the status of the machine
- Record function of previous breakdowns including irregular and transient malfunction

Maintenance information display

# Quality That Keeps on Shining. Valuable Assets Take Your Business to the Next Level

Structural strength and proven reliability mean these machines can deal with heavy work loads and perform in rigorous site environments. From the lifecycle viewpoint, these machines maintain their value throughout their service lives.



## Easy, on-the-spot maintenance NEW



### Urea tank

Urea filler cap is placed on the step for easy access.



### Engine maintenance

Setting up maintenance area one step down allows easy access to the engine.



### Handhold

The handrail is placed on the boom side. In addition, the distance between the current handrails was increased to allow easier access to the maintenance port on the upper arm.

## Maintenance work, daily checks, etc. can be done from ground level

The layout allows for easy access from the ground for many daily checks and regular maintenance tasks.



Engine oil filter



Hydraulic pump



INDr filter/radiator reservoir tank/air cleaner

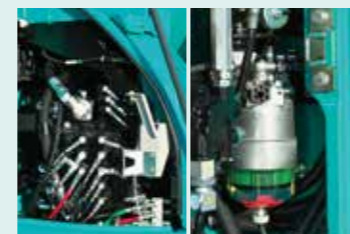

Control valve/water separator

## Fast maintenance requires only a few procedures



Washer fluid tank is located under the cab floor mat.



Engine oil quick-drain valve can be turned without special tool.



Fuel tank features bottom flange and large drain valve.

## Improved Filtration System Reliability

Clean, contaminant-free fuel and hydraulic fluid are essential to stable performance. The improved filtration systems reduce the risk of mechanical trouble and enhance longevity and durability.

### Hydraulic fluid filter NEW

Recognized as the best in the industry, our premium-fine filter separates out even the smallest particles. New cover prevents contamination when changing filters.



### Hydraulic fluid filter clog detector NEW

Pressure sensors at the inlet and outlet of the hydraulic fluid filter monitor differences in pressure to determine the degree of clogging. If the difference in pressure exceeds a predetermined level, a warning appears on the multi-display, so any contamination can be removed from the filter before it reaches the hydraulic fluid reservoir.

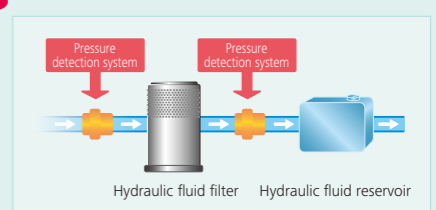

### Fuel filter with built-in NEW

Water separator fuel filter with built-in water separator maximizes filtering performance.



60% enlarged

Long-life hydraulic oil: 5,000 hours

### Long-interval maintenance

Long-life hydraulic oil reduces cost and labor.

Replacement cycle: 1,000 hours

### Highly durable premium-fine filter

The high-capacity hydraulic oil filter incorporates glass fiber with superior cleaning power and durability.

## Easy cleaning saves time



### Double-element air cleaner

The large-capacity element features a double-filter structure that keeps the engine running clean even in industrial environments.



Detachable two-piece floor mat has handles for easy removal. The mat's raised edges trap dirt and grit for easy cleaning.



Special crawler frame design makes it easy to clean off mud.



# GEOSCAN

## Excavator Remote Monitoring System



### Direct Access to Operational Status

#### Location data

Accurate location data can be obtained even from sites where communications are difficult.

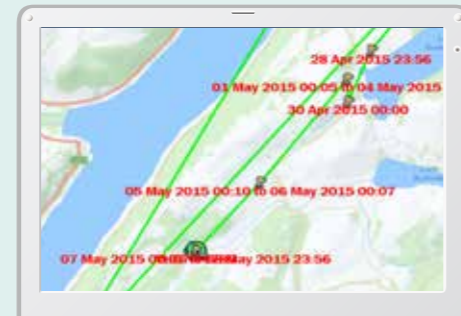
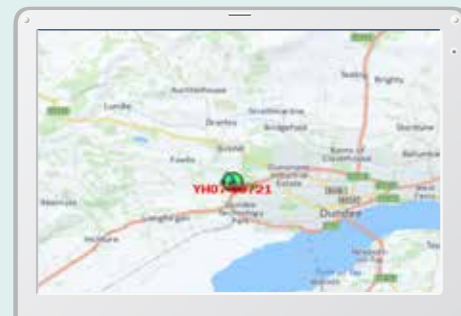

Work data

Type of Operation	Working Hrs	Ratio
Total Working Hrs	169 Hrs	100 %
Digging Hrs	72.2 Hrs	43 %
Traveling Hrs	18.3 Hrs	11 %
Idle Hrs	15.9 Hrs	9 %
Opt Att Hrs	62.5 Hrs	37 %
Crane Mode Hrs	0 Hrs	0 %

#### Operating hours

- A comparison of operating times of machines at multiple locations shows which locations are busier and more profitable.
- Operating hours on site can be accurately recorded, for running time calculations needed for rental machines, etc.

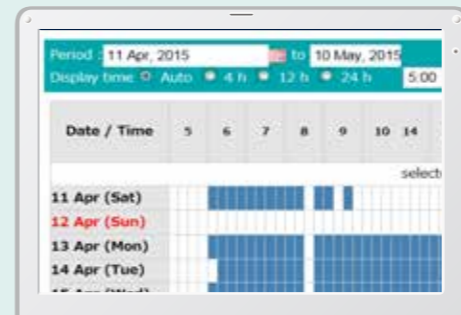

#### Fuel consumption data

- Data on fuel consumption and idling times can be used to indicate improvements in fuel consumption.

Fuel consumption

Work mode	Working Hrs	Total Fuel Consumption
H mode	2:06	24.5 L
S mode	0:00	0.0 L
E mode	169:19	1489.7 L
<b>TOTAL</b>	<b>171:25</b>	<b>1514.2 L</b>

#### Graph of work content

- The graph shows how working hours are divided among different operating categories, including digging, idling, traveling and optional operations.



### Maintenance Data and Warning Alerts

#### Machine maintenance data

- Provides maintenance status of separate machines operating at multiple sites.
- Maintenance data is also relayed to KOBELCO service personnel, for more efficient planning of periodic servicing.

Maintenance

Model	Serial No.	Hour Meter	Engine Oil
SK135SRLC-3/SK140SRL	YH07-09721	734 Hr	434
SK135SRLC-3/SK140SRL	YH07-09789	73 Hr	429
SK210LC-9	YQ13-10454	960 Hr	58
SK210LC-9	YQ13-10481	549 Hr	498
SK75SR-	YT08-30174		

#### Warning alerts

- This system warns an alert if an anomaly is sensed, preventing damage that could result in machine downtime.

#### Alarm information can be received through E-mail

- Alarm information or maintenance notice can be received through E-mail, using a computer or cell phone.

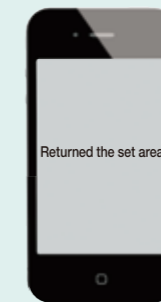

Messages displayed when the machine returns to the set area.

#### Daily/Monthly reports

- Operational data downloaded onto a computer helps in formulating daily and monthly reports.

### Security system

#### Engine start alarm

- The system can be set an alarm if the machine is operated outside designated time.

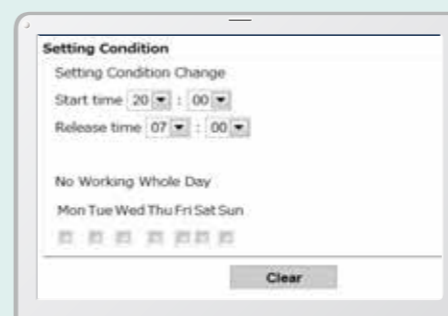

Engine start alarm outside prescribed work time

#### Area alarm

- It can be set an alarm if the machine is moved out of its designated area to another location.

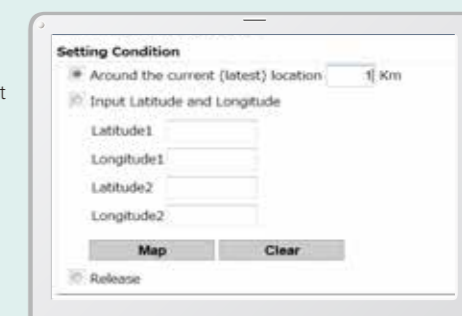

Alarm for outside of reset area



## Engine

Model	ISUZU 4JJ1XDRA
Type	4-stroke liquid-cooled direct injection diesel turbo charged with intercooler, stage 4 certified
No. of cylinders	4
Bore and stroke	95.4 mm x 104.9 mm
Displacement	2.999 L
Rated power output	73.9kW/2,000 min <sup>-1</sup> (ISO 9249)
	78.5kW/2,000 min <sup>-1</sup> (ISO 14396)
Max. torque	357N·m/1,800 min <sup>-1</sup> (ISO 9249)
	375N·m/1,800 min <sup>-1</sup> (ISO 14396)

## Hydraulic System

<b>Pump</b>	
Type	Two variable displacement piston pumps + one gear pump
Max. discharge flow	2 x 130 L/min, 1 x 20 L/min
<b>Relief valve setting</b>	
Boom, arm and bucket	34.3 Mpa {350 kgf/cm <sup>2</sup> }
Travel circuit	34.3 Mpa {350 kgf/cm <sup>2</sup> }
Swing circuit	28.0 Mpa {285 kgf/cm <sup>2</sup> }
Control circuit	5.0 Mpa {50 kgf/cm <sup>2</sup> }
Pilot control pump	Gear type
Main control valves	8-spool
Oil cooler	Air cooled type

## Swing System

Swing motor	One fixed displacement piston motor	
Brake	Hydraulic; locking automatically when the swing control lever is in the neutral position	
Parking brake	Wet multiple plate, hydraulic operated automatically	
Swing speed	11.0 min <sup>-1</sup>	
Swing torque	39.9 kN.m	
Tail swing radius	SK135SR	1,490 mm
	SK140SR <sub>LC</sub>	1,600 mm
Min. front swing radius	2,000 mm	

## Attachments

Backhoe bucket and combination

Use	Backhoe bucket				
	Normal digging				
Bucket capacity	ISO heaped	m <sup>3</sup>	0.38	0.45	0.50
	struck	m <sup>3</sup>	0.28	0.35	0.38
Opening width	With side cutter	mm	800	910	1,000
	Without side cutter	mm	700	820	900
No. of teeth			4	4	5
Bucket weight		kg	320	360	390
Combination	2.38m standard arm		○	○	◎
	2.84m long arm		○	△	×

◎ Standard ○ Recommend △ Loading only × Not recommended

## Travel System

Travel motors	Displacement piston motor
Travel brakes	Hydraulic brake per motor
Parking brakes	Wet multiple plate per motor
Travel shoes	44 each side
Travel speed	5.6 / 3.4 km/h
Drawbar pulling force	138 kN {14,100 kgf} (ISO 7464)
Gradeability	70% {35°}

## Cab & Control

<b>Cab</b>	All-weather, sound-suppressed steel cab mounted on the silicon-sealed viscous mounts and equipped with a heavy, insulated floor mat.
<b>Control</b>	Two hand levers and two foot pedals for travel Two hand levers for excavating and swing Electric rotary-type engine throttle

## Boom, Arm & Bucket

Boom cylinders	100 mm x 1,092 mm
Arm cylinder	115 mm x 1,120 mm
Bucket cylinder	95 mm x 903 mm

## Refilling Capacities & Lubrications

Fuel tank	190 L
Cooling system	9.0 L
Engine oil	13.0 L
Travel reduction gear	2 x 2.1 L
Swing reduction gear	0.4 L
Hydraulic oil tank	79.3 L tank oil level
	168.0 L hydraulic system
Urea tank	33.9 L

## Working Ranges

Unit: m

Range	4.68m	
	Standard 2.38m	Long 2.84m
a- Max. digging reach	8.34	8.78
b- Max. digging reach at ground level	8.19	8.64
c- Max. digging depth	5.52	5.98
d- Max. digging height	9.19	9.56
e- Max. dumping clearance	6.74	7.11
f- Min. dumping clearance	2.58	2.22
g- Max. vertical wall digging depth	4.89	5.44
h- Min. swing radius	2.00	2.4
i- Horizontal digging stroke at ground level	4.21	4.7
j- Digging depth for 2.4 m (8') flat bottom	5.29	5.79
Bucket capacity ISO heaped m <sup>3</sup>	0.50	0.38

Unit: kN

Arm length	Standard 2.38m	Long 2.84m
Bucket digging force	90.1 {9,190}	
Arm crowding force	64.4 {6,570}	58.1 {5,920}

## Dimensions

Arm length		Standard 2.38m	Long 2.84m
A Overall length	SK135SR	7,410	
	SK140SR <sub>LC</sub>	7,490	
B Overall width		2,490**	
C Overall height (to top of cab)		2,860	
D Ground clearance of rear end*		855	
E Ground clearance*		440	
F Tail swing radius	SK135SR	1,490	
	SK140SR <sub>LC</sub>	1,600	

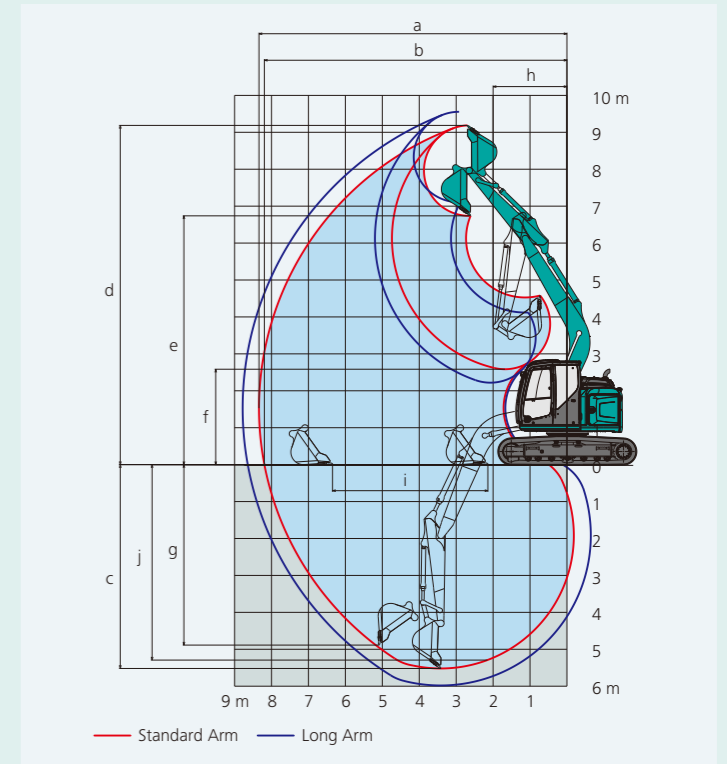

Unit: mm

F'	Distance from center of swing to rear end	SK135SR	1,490
		SK140SR <sub>LC</sub>	1,600
G	Tumbler distance	SK135SR	2,870
		SK140SR <sub>LC</sub>	3,040
H	Overall length of crawler	SK135SR	3,580
		SK140SR <sub>LC</sub>	3,750
I	Track gauge	1,990	
J	Shoe width	500/600/700	
K	Overall width of upperstructure	2,490	

\*Without including height of shoe lug.  
\*\*500mm shoe

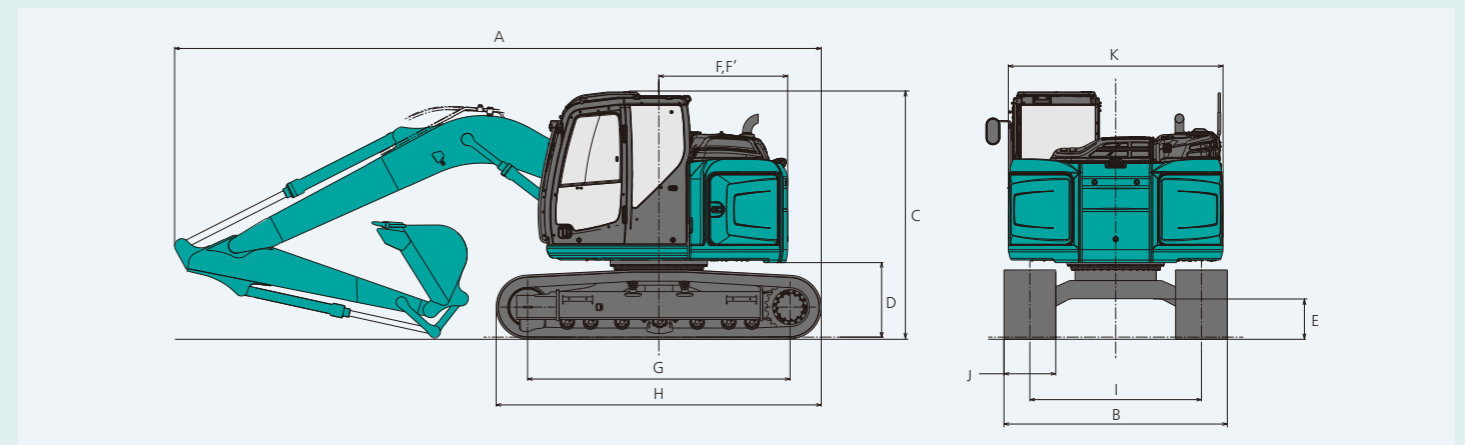

## Operating Weight & Ground Pressure

In standard trim, with standard boom, 2.38 m arm, and 0.5 m<sup>3</sup> ISO heaped bucket

Shaped		Triple grouser shoes (even height)		
Shoe width	mm	500	600	700
Overall width of crawler	mm	2,490	2,590	2,690
Ground pressure	kPa	SK135SR without dozer	44	37
		SK140SR <sub>LC</sub> with dozer		
Operating weight	kg	SK135SR without dozer	14,000	14,200
		SK140SR <sub>LC</sub> with dozer		14,400

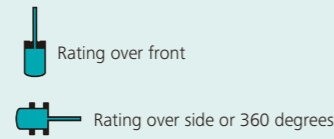
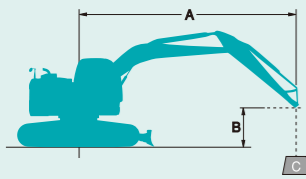

A: Reach from swing centerline to arm top  
 B: Arm top height above/below ground  
 C: Lifting capacities in Kilograms  
 Bucket: Without bucket  
 Relief valve setting: 34.3 MPa {350 kgf/cm<sup>2</sup>}

SK135SR		Arm: 2.38m Bucket: Without Counterweight: 3,140kg Shoe: 500mm Dozer: Without										
B	A	1.5 m		3.0 m		4.5 m		6.0 m		At Max. Reach		Radius
		Rating over front	Rating over side or 360 degrees	Rating over front	Rating over side or 360 degrees	Rating over front	Rating over side or 360 degrees	Rating over front	Rating over side or 360 degrees	Rating over front	Rating over side or 360 degrees	
7.5m	kg									*2,310	*2,310	3.67m
6.0m	kg					*3,510	3,450			*1,810	*1,810	5.47m
4.5m	kg			*4,380	*4,380	*3,760	3,370	3,050	2,090	*1,670	*1,670	6.44m
3.0m	kg			*6,570	5,890	*4,500	3,150	2,970	2,020	1,660	1,570	6.96m
1.5m	kg			*5,620	5,140	4,420	2,890	2,850	1,910	1,750	1,470	7.11m
G.L.	kg			*6,070	4,920	4,230	2,720	2,760	1,830	1,960	1,490	6.93m
-1.5m	kg	*5,180	*5,180	*8,070	4,920	4,170	2,670	2,740	1,800	2,410	1,660	6.40m
-3.0m	kg	*8,940	*8,940	*6,440	5,040	4,230	2,720			3,260	2,140	5.39m

SK135SR		Arm: 2.84m Bucket: Without Counterweight: 3,140kg Shoe: 500mm Dozer: Without												
B	A	1.5 m		3.0 m		4.5 m		6.0 m		7.5 m		At Max. Reach		Radius
		Rating over front	Rating over side or 360 degrees	Rating over front	Rating over side or 360 degrees	Rating over front	Rating over side or 360 degrees	Rating over front	Rating over side or 360 degrees	Rating over front	Rating over side or 360 degrees	Rating over front	Rating over side or 360 degrees	
7.5m	kg											*2,040	*2,040	4.49m
6.0m	kg					*3,030	*3,030	*1,840	*1,840			*1,680	*1,680	6.04m
4.5m	kg					*3,320	*3,320	3,050	2,080			*1,560	*1,560	6.93m
3.0m	kg			*5,630	*5,630	*4,070	3,150	2,940	1,980			*1,550	1,360	7.41m
1.5m	kg			*8,020	5,200	4,400	2,860	2,810	1,860	*1,920	1,290	*1,630	1,270	7.55m
G.L.	kg			*6,280	4,810	4,160	2,650	2,690	1,750			*1,800	1,280	7.39m
-1.5m	kg	*4,420	*4,420	8,200	4,740	4,060	2,560	2,640	1,700			*2,150	1,410	6.89m
-3.0m	kg	*7,500	*7,500	*7,010	4,830	4,080	2,580					2,710	1,760	5.96m
-4.5m	kg			*4,280	*4,280							*2,660	*2,660	4.34m

SK140SR <sup>LC</sup>		Arm: 2.38m Bucket: Without Counterweight: 3,140kg Shoe: 500mm Dozer: Without										
B	A	1.5 m		3.0 m		4.5 m		6.0 m		At Max. Reach		Radius
		Rating over front	Rating over side or 360 degrees	Rating over front	Rating over side or 360 degrees	Rating over front	Rating over side or 360 degrees	Rating over front	Rating over side or 360 degrees	Rating over front	Rating over side or 360 degrees	
7.5m	kg									*2,310	*2,310	3.67m
6.0m	kg					*3,510	*3,510			*1,810	*1,810	5.47m
4.5m	kg			*4,380	*4,380	*3,760	3,500	*3,240	2,190	*1,670	*1,670	6.44m
3.0m	kg			*6,570	6,140	*4,500	3,280	3,350	2,110	*1,660	1,650	6.96m
1.5m	kg			*5,620	5,390	5,040	3,030	3,240	2,010	*1,750	1,550	7.11m
G.L.	kg			*6,070	5,160	4,840	2,860	3,150	1,920	*1,960	1,570	6.93m
-1.5m	kg	*5,180	*5,180	*8,070	5,160	4,780	2,810	3,120	1,900	*2,410	1,750	6.40m
-3.0m	kg	*8,940	*8,940	*6,440	5,280	*4,470	2,860			*3,360	2,250	5.39m

- Do not attempt to lift or hold any load that is greater than these lift capacities at their specified lift point radius and heights. Weight of all accessories must be deducted from the above lift capacities.
- Lift capacities are based on machine standing on level, firm, and uniform ground. User must make allowance for job conditions such as soft or uneven ground, out of level conditions, side loads, sudden stopping of loads, hazardous conditions, experience of personnel, etc.
- Arm top defined as lift point.

- The above lifting capacities are in compliance with ISO 10567. They do not exceed 87% of hydraulic lifting capacity or 75% of tipping load. Lifting capacities marked with an asterisk (\*) are limited by hydraulic capacity rather than tipping load.
- Operator should be fully acquainted with the Operator's and Maintenance Instructions before operating this machine. Rules for safe operation of equipment should be adhered to at all times.
- Lift capacities apply to only machine as originally manufactured and normally equipped by KOBELCO CONSTRUCTION MACHINERY CO., LTD.

## STANDARD EQUIPMENT

### ENGINE

- Engine, ISUZU, 4JJ1XDRA Diesel engine with turbocharger and intercooler, Stage 4 certified
- Automatic engine deceleration
- Auto idle Stop (AIS)
- Batteries (2 x12V - 80 Ah)
- Starting motor (24 V - 4kW), 50 amp alternator
- Automatic engine shut-down for low engine oil pressure
- Engine oil pan drain cock
- Double element air cleaner

### CONTROL

- Working mode selector (H-mode, S-mode and ECO-mode)
- N&B piping (proportional hand controlled)
- Extra piping (proportional hand controlled)
- Quick Hitch piping

### SWING SYSTEM & TRAVEL SYSTEM

- Swing rebound prevention system
- Straight propel system
- Two-speed travel with automatic shift down
- Sealed & lubricated track links
- 500mm track shoes
- Grease-type track adjusters
- Automatic swing brake

### MIRRORS, CAMERA & LIGHTS

- Three rear view mirrors, rearview camera
- Two front working lights

### CAB & CONTROL

- Two control levers, pilot-operated
- Tow eyes
- Horn, electric
- Integrated left-right slide-type control box
- Cab light (interior)
- Coat hook
- Luggage tray
- Large cup holder
- Detachable two-piece floor mat
- Headrest
- Handrails
- Intermittent windshield wiper with double-spray washer
- Skylight
- Top guard (ISO 10262 : 1998)
- Tinted safety glass
- Pull-type front window and removable lower front window
- Easy-to-read multi-display monitor
- Automatic air conditioner
- Emergency escape hammer
- Suspension seat
- Radio, AM/FM stereo with speakers
- Boom & Arm safety valve
- Geoscan
- Travel alarm
- Lower under cover

## OPTIONAL EQUIPMENT

- Various optional arms
- Wide range of shoes
- Additional track guide
- Multi control valve
- Front-guard protective structure (may interfere with bucket action)
- Add-on counterweight (+580kg)

- Two cab lights
- Air suspension seat
- Rain visor (may interfere with bucket action)
- Dozer blade (for 500mm,600mm and 700mm shoe)
- Right Side view camera

Note: Standard and optional equipment may vary. Consult your KOBELCO dealer for specifics.