

KOBELCO

SK135SR/SK140SRLC-7

Performance  Design

SK135SR SK140SRLC

- Bucket capacity:
0.38 – 0.50 m³
- Engine power:
78.6 kW/2,200 min⁻¹
- Operating weight:
14,500 – 16,000 kg



We Save You Fuel
Achieving a Low-Carbon Society



SK135SR



Performance Design

With the release of the SK135SR-7 and SK140SRLC-7, KOBELCO has completely harmonised the values of PERFORMANCE and DESIGN.

The SK135SR delivers greater efficiency and productivity with increased power and speed, along with uncompromising operator comfort and machine operability.

In the pursuit of producing unique and unbeatable machines that provide comfort and productivity without equal, KOBELCO continues to rise to the challenge.

THE ULTIMATE SLEEK AND STYLISH CAB DESIGN

True ergonomic functionality combined with modern design has resulted in a cabin interior that is sleek and comfortable, built for simplicity and operator comfort.

Jog dial

The jog dial integrates multiple functions to allow for simple navigation of machine information screens, even while wearing gloves.

LED backlights

LED backlighting on switches and dials provides a bright, clear view of controls, even in the dark, while delivering a premium look and feel.







UNFORGETTABLE COMFORT

① Air suspension seat

A GRAMMER seat is installed as standard equipment, which achieves excellent shock absorption and superior ride comfort.



② Optimal air conditioning vent placement

Air conditioning vents are optimally placed around the cabin with air flow directed toward the operator's neck and back, providing more comfortable operation.

③ Ergonomic and low-effort pilot control levers

Pilot control levers are mounted on adjustable consoles, with an ergonomic design that allows movement without twisting, reducing operator fatigue.



New Hydraulic Control

Our newly upgraded hydraulic control system responds to shorter lever strokes than current models, delivering swifter, more precise movement and improved lever operability.

④ LED door light

The LED interior light automatically turns on when the door is opened or when the ignition is set to OFF. This ensures easy entry and exit at nighttime.



KOBELCO

ECO

04:33



SETTING MENU



PICTURE OF CAMERA



CLOCK SETTING



SCREEN BRIGHTNESS



MAINTENANCE



CONSUMPTION



LANGUAGE SELECTION



FLOW RATE 260 l/min

A WIDER VIEW BRINGS A WIDER RANGE OF USE

10-inch colour monitor—the largest in the industry

The easy-to-operate menu screen facilitates easy reading and navigation. Images from the built-in cameras can be checked on the large screen, which helps to improve safety. In addition, each icon is easily recognisable.

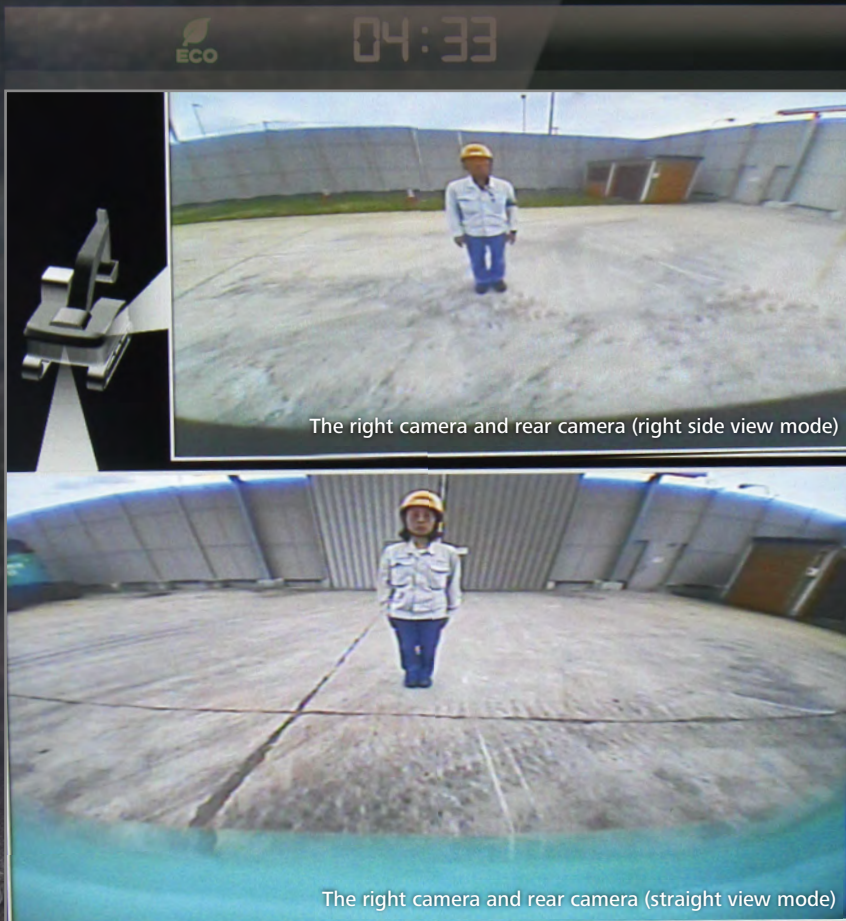

The right camera and rear camera (right side view mode)

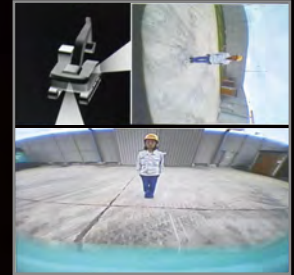

The right camera and rear camera (straight view mode)

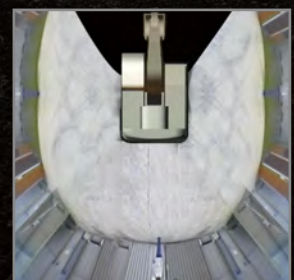
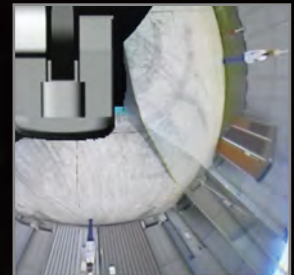

SAFETY ON FULL DISPLAY

Our high-resolution, large display shows right, left and rear side cameras together. Multiple camera modes allow operators to customize their display based on their needs to enhance awareness and jobsite safety.



Screen display linked with the jog dial operation

The jog dial provides simple and intuitive control of all display screens. Turn the jog dial to the right or left to select an item and press the dial to confirm the selection.



THE NEXT LEVEL OF PERFORMANCE

Our high-power engine complies with Tier 4 Final emission regulations

Compared to previous models, the engine output is significantly increased, which shortens the digging cycle time substantially. It attains high performance without reducing the speed even when heavy a load is applied or when travelling on a slope.



Model: ISUZU 4JJ1XDRAC

Engine output

78.6kW/2,200min⁻¹
ISO9249 With fan

>>> Digging cycle time Shortened by 10%
(Compared to the SK135SR-5 model)



Bucket Digging Force

105.4 kN (ISO6015)

Increased by **17**%

(Compared to the SK135SR-5 model)



GREATER MULTI-FUNCTION CAPABILITIES

Attachment mode

The flow-rate modes of the bucket, breaker, nibbler, and rotating grapple are set before delivery, which allows you to start operating immediately. Mode settings for other attachments, such as the tilt rotator, can easily be added or changed.



Adjustment for hydraulic flow

Divide ratio of hydraulic flow can be adjusted by service factory for custom usage.

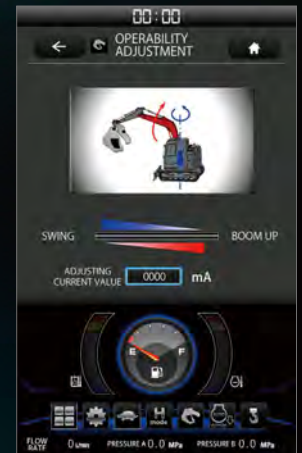

NON-STOP OPERATION BY iNDr

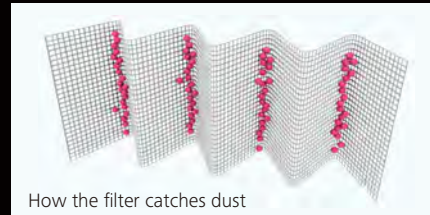
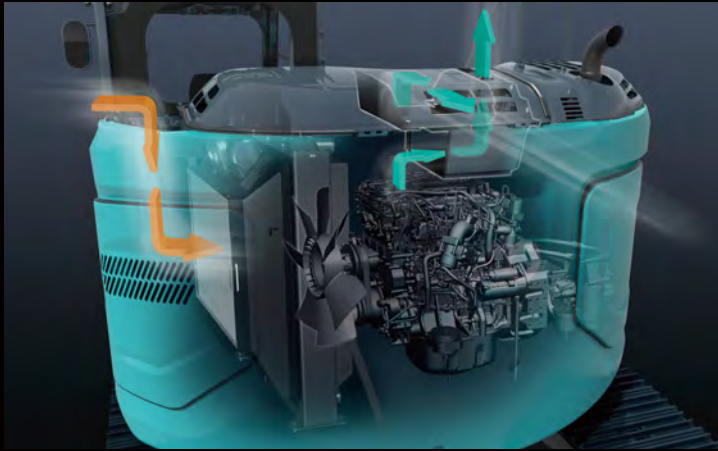

How the filter catches dust

iNDr Filter

A high-density stainless steel mesh filter blocks dust and debris from entering the cooling package during air intake. This prevents the cooling package and air cleaner from clogging, allowing the machine to maintain cooling performance. The ridges of the corrugated filter allow air to pass through, while the grooves collect dust and debris, preventing the filter from clogging.

CONVENIENT AND SENSIBLE EQUIPMENT



Adjustable height pilot control levers

Operator can adjust height of attachment control levers.



AM/FM Bluetooth® (hands-free) radio

Audio streaming and hands free phone calling capability.
 **Bluetooth® is a registered trademark of the Bluetooth SIG Inc.



USB port / 12V power outlet



Smartphone holder

You can use the holder with your smartphone connected to the USB port.

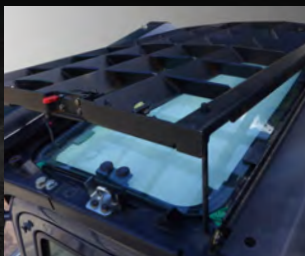

Opening Top guard

The Top guard is hinged, allowing easy access to the top window for serviceability.



Ground level AdBlue* tank

* AdBlue® is a registered trade mark of the Verband der Automobilindustrie e. V. (VDA).



Rear camera



Left camera

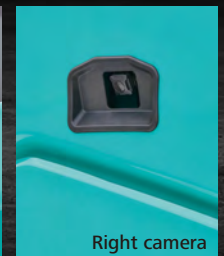

Right camera

Standard built-in rear, left and right side cameras

GEOSCAN

Excavator Remote Monitoring System



Direct Access to Operational Status

Location Data

• Accurate location data can be obtained even from sites where communications are difficult.

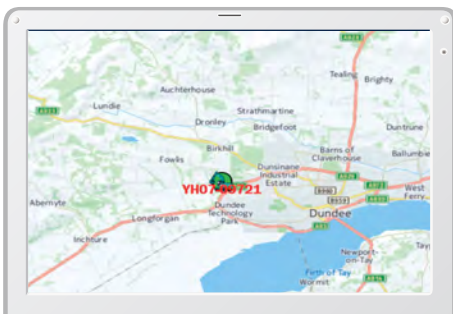

Latest location

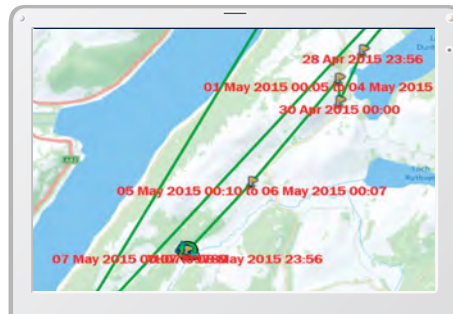

Location records

Type of Operation	Working Hrs	Ratio
Total Working Hrs	169 Hrs	100 %
Digging Hrs	72.2 Hrs	43 %
Traveling Hrs	18.3 Hrs	11 %
Idle Hrs	15.9 Hrs	9 %
Opt Att Hrs	62.5 Hrs	37 %
Crane Mode Hrs	0 Hrs	0 %

Work data

Operating Hours

- A comparison of operating times of machines at multiple locations shows which locations are busier and more profitable.
- Operating hours on site can be accurately recorded, for running time calculations needed for rental machines, etc.

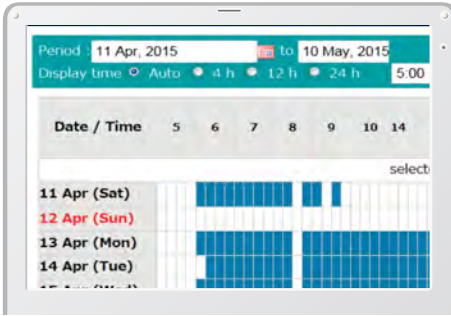

Daily report

Fuel Consumption Data

- Data on fuel consumption and idling times can be used to indicate improvements in fuel consumption.

Work mode	Working Hrs	Total Fuel Consumption
H mode	2:06	24.5 L
S mode	0:00	0.0 L
E mode	169:19	1489.7 L
TOTAL	171:25	1514.2 L

Fuel consumption

Graph of Work Content

- The graph shows how working hours are divided among different operating categories, including digging, idling, travelling and optional operations.

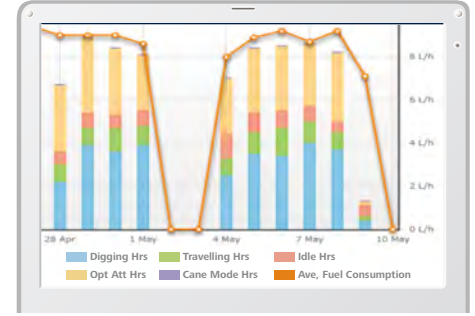

Work status

Maintenance Data and Warning Alerts

Machine Maintenance Data

- Provides maintenance status of separate machines operating at multiple sites.
- Maintenance data is also relayed to KOBELCO service personnel, for more efficient planning of periodic servicing.

Model	Serial No.	Hour Meter	Engine Oil
SK135SRLC-3/SK140SRL	YH07-09721 0.38/0.35	734 Hr	434
SK135SRLC-3/SK140SRL	YH07-09789 0.38/0.35	73 Hr	429
SK210LC-9	YQ13-10454 0.8/0.7	960 Hr	58
SK210LC-9	YQ13-10481 0.8/0.7	549 Hr	498
SK75SR-	YT08-30374		

Maintenance

Warning Alerts

- This system gives an alert if an anomaly is sensed, preventing damage that could result in machine downtime.

Alarm Information Can Be Received via E-mail

- Alarm information or maintenance notice can be received via e-mail, using a computer or a mobile device.



Alarm messages can be received on a mobile device.

Daily/Monthly Reports

- Operational data downloaded onto a computer helps in formulating daily and monthly reports.

Security System

Engine Start Alarm

- The system can be set up with an alarm if the machine is operated outside designated time.

Engine start alarm outside prescribed work time

Area Alarm

- It can be set up with an alarm if the machine is moved out of its designated area to another location.

Alarm for outside of reset area

Specifications

Engine

Model	ISUZU 4JJ1XDRAC
Type	Four-cycle, liquid-cooled, direct injection diesel, turbo charged, Tier IV Final certified
No. of cylinders	4
Bore and stroke	95.4 mm x 104.9 mm
Displacement	2.999 L
Rated power output	78.6 kW/2,200 min ⁻¹ (ISO 9249: with fan)
	86.0 kW/2,200 min ⁻¹ (ISO 14396: without fan)
Max. torque	354 N·m/1,800 min ⁻¹ (ISO 9249: with fan)
	375 N·m/1,800 min ⁻¹ (ISO 14396: without fan)

Hydraulic system

Pump	
Type	Two variable displacement piston pumps + one gear pump
Max. discharge flow	2 x 142 L/min
	1 x 22 L/min
	Optional gear pump 1 x 66 L/min
Relief valve setting	
Boom, arm and bucket	34.3 Mpa
Travel circuit	34.3 Mpa
Swing circuit	28.0 Mpa
Control circuit	5.0 Mpa
Pilot control pump	Gear type
Main control valves	12-spool
Oil cooler	Air cooled type

Swing system

Swing motor	One fixed displacement piston motor
Brake	Hydraulic; locking automatically when the swing control lever is in the neutral position
Parking brake	Wet multiple plate
Swing speed	11.0 min ⁻¹
Swing torque	40.4 kN·m

Attachments

Backhoe bucket and combination

Use	Backhoe bucket				
	Normal digging				
Bucket capacity	ISO heaped	m ³	0.38	0.45	0.50
	struck	m ³	0.28	0.35	0.38
Opening width	With side cutter	mm	800	915	1,000
	Without side cutter	mm	740	855	940
No. of teeth			4	4	5
Bucket weight		kg	340	360	390
Combination	2.38m standard arm		○	○	◎
	2.84m long arm		◎	△	×

◎ Standard ○ Recommend △ Loading only × Not recommended

Travel system

Travel motors	Variable displacement piston, two-speed motors
Travel brakes	Hydraulic brake
Parking brakes	Wet multiple plate
Travel shoes	44 each side (SK135SR)
	46 each side (SK140SRLC)
Travel speed	3.4 / 5.6 km/h
Drawbar pulling force	141 kN (ISO 7464)
Gradeability	70% (35°)

Cab & control

Cab

All-weather, sound-suppressed steel cab mounted on the silicon-sealed viscous mounts and equipped with a heavy, insulated floor mat

Control

Two hand levers and two foot pedals for travel

Two hand levers for excavating and swing

Electric rotary-type engine throttle

Boom, arm & bucket

Boom cylinders	100 mm x 1,092 mm
Arm cylinder	115 mm x 1,116 mm
Bucket cylinder	100 mm x 903 mm

Dozer blade (optional)

Dozer cylinder	125 mm x 220 mm
Dimension	2,490 mm (for 500 mm shoe) (width) x 570 mm (height)*
Working range	500 mm (up) x 590 mm (down)

*Dozer width is changed according to the shoe width difference.

Refilling capacities & lubrications

Fuel tank	186 L
Cooling system	17 L
Engine oil	17 L
Travel reduction gear	2 x 2.1 L
Swing reduction gear	1.65 L
Hydraulic oil tank	89.9 L tank oil level
	176 L hydraulic system
Urea tank	20.7L

SK135SR SK140SR_{LC}

SK135SR-7

SK140SR_{LC}-7

Working ranges

Unit: m

Range	Boom 4.68 m	
	Arm 2.38 m	2.84 m
a- Max. digging reach	8.37	8.81
b- Max. digging reach at ground level	8.21	8.66
c- Max. digging depth	5.52	5.98
d- Max. digging height	9.18	9.55
e- Max. dumping clearance	6.75	7.11
f- Min. dumping clearance	2.62	2.25
g- Max. vertical wall digging depth	4.50	4.95
h- Min. swing radius	2.13	2.52
i- Horizontal digging stroke at ground level	4.19	4.67
j- Digging depth for 2.4 m (8') flat bottom	5.29	5.78
Bucket capacity ISO heaped m ³	0.50	0.38

Digging force (ISO 6015)

Unit: kN

Arm length	2.38 m	2.84 m
Bucket digging force	105.4	
Arm crowding force	64.0	58.0

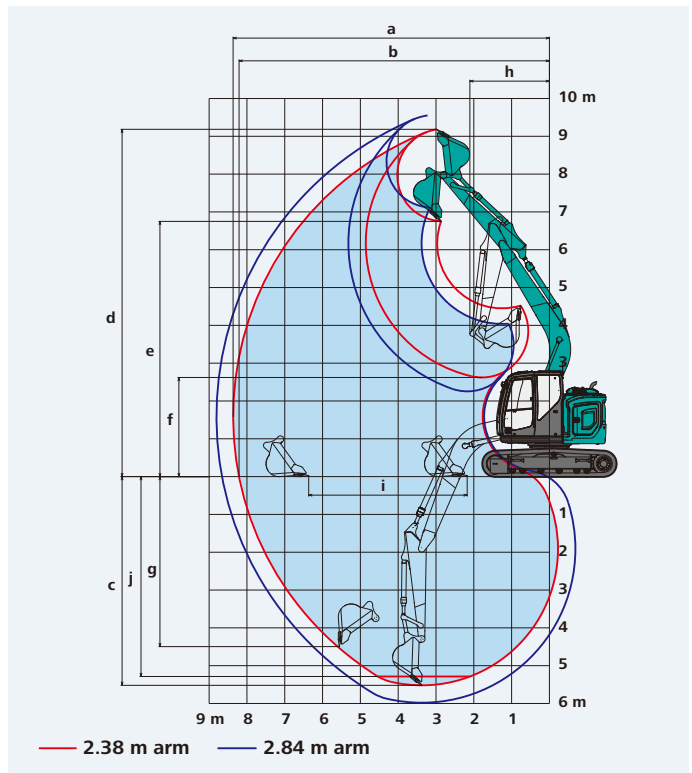

Dimensions

Unit: mm

Arm length	2.38 m	2.84 m
A Overall length	8,070	8,080
B Overall height (to top of boom)	2,790	3,140
C Overall width	2,490**	
D Overall height (to top of cab)	2,860	
E Ground clearance of rear end*	870	
F Ground clearance*	400	
G Tail swing radius	1,490	

G'	Distance from centre of swing to rear end	1,490
H	Tumbler distance	SK135SR: 2,870
		SK140SR _{LC} : 3,040
I	Overall length of crawler	SK135SR: 3,580
		SK140SR _{LC} : 3,750
J	Track gauge	1,990
K	Shoe	500
L	Overall width of upperstructure	2,480
M	Dozer blade (up / down)***	500 / 590

*Without including height of shoe lug **500 mm shoe ***Dozer blade is optional equipment

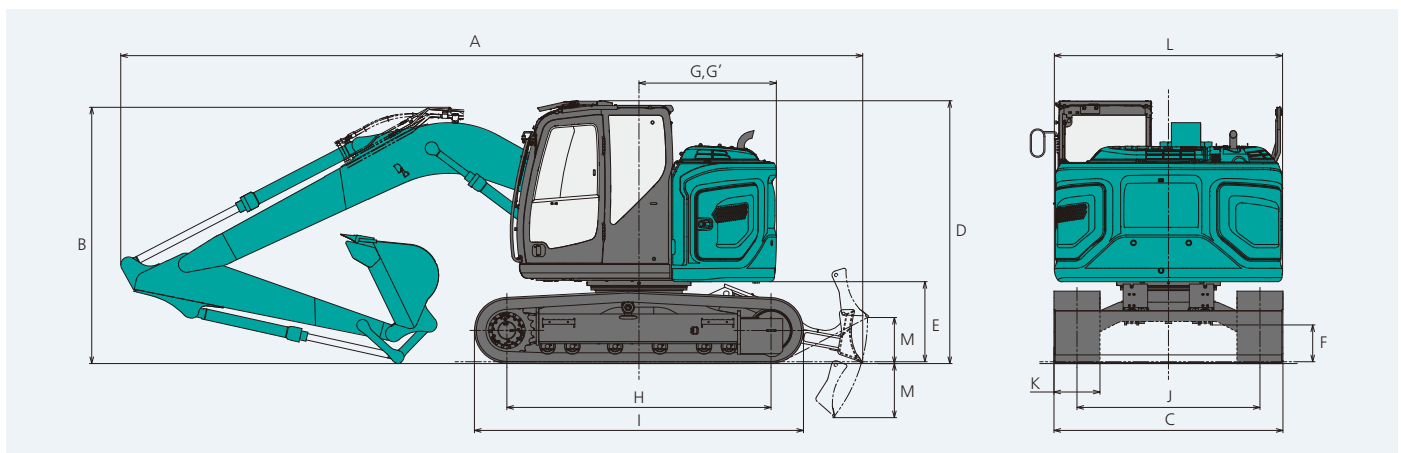

Operating weight & ground pressure

In standard trim, with standard boom, 2.38 m arm, and 0.5 m³ ISO heaped bucket

Shaped		Triple grouser shoes (even height)			
Shoe width	mm	500	600	700	
Overall width of crawler	mm	2,490	2,590	2,690	
Ground pressure	kPa	SK135SR without dozer	45.4	38.6	33.6
		SK140SR _{LC} with dozer	46.1	39.2	34.1
Operating weight	kg	SK135SR without dozer	14,500	14,700	14,900
		SK140SR _{LC} with dozer	15,500	15,800	16,000

Lift capacities

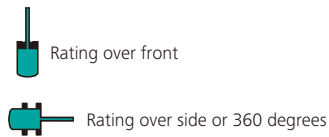
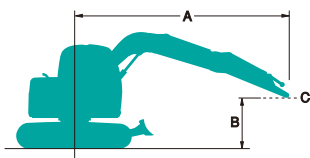

A - Reach from swing centerline to arm top
 B - Arm top height above/below ground
 C - Lift point
 Bucket: Without bucket
 Relief valve setting: 34.3 MPa {350kgf/cm²}













SK135SR		Arm: 2.38 m Bucket: Without Counterweight: 3,150 kg Shoe: 500 mm Dozer: Less										
B \ A		1.5 m		3.0 m		4.5 m		6.0 m		At max. reach		Radius
7.5 m	kg									*2,270	*2,270	3.80 m
6.0 m	kg					*3,390	*3,390			*1,800	*1,800	5.55 m
4.5 m	kg			*4,280	*4,280	*3,670	3,460	3,140	2,140	*1,670	*1,670	6.50 m
3.0 m	kg			*6,540	6,000	*4,420	3,210	3,040	2,060	*1,670	1,580	6.99 m
1.5 m	kg			*5,240	5,190	4,510	2,930	2,920	1,940	*1,760	1,480	7.14 m
G.L.	kg			*6,020	4,980	4,310	2,760	2,820	1,850	*1,980	1,510	6.94 m
-1.5 m	kg	*5,300	*5,300	*8,050	4,990	4,250	2,710	2,800	1,830	*2,430	1,690	6.39 m
-3.0 m	kg	*9,070	*9,070	*6,440	5,130	4,330	2,770			3,360	2,200	5.36 m













SK135SR		Arm: 2.38 m Bucket: Without Counterweight: 3,150 kg Shoe: 500 mm Dozer: Blade up										
B \ A		1.5 m		3.0 m		4.5 m		6.0 m		At max. reach		Radius
7.5 m	kg									*2,270	*2,270	3.80 m
6.0 m	kg					*3,390	*3,390			*1,800	*1,800	5.55 m
4.5 m	kg			*4,280	*4,280	*3,670	3,640	3,220	2,270	*1,670	*1,670	6.50 m
3.0 m	kg			*6,540	6,320	*4,420	3,390	3,120	2,180	*1,670	*1,670	6.99 m
1.5 m	kg			*5,240	*5,240	4,630	3,110	3,000	2,070	*1,760	1,590	7.14 m
G.L.	kg			*6,020	5,300	4,430	2,940	2,900	1,980	*1,980	1,610	6.94 m
-1.5 m	kg	*5,300	*5,300	*8,050	5,310	4,370	2,890	2,880	1,950	*2,430	1,800	6.39 m
-3.0 m	kg	*9,070	*9,070	*6,440	5,450	4,450	2,950			*3,380	2,350	5.36 m

SK135SR SK140SR_{LC}

SK135SR-7

SK140SR_{LC}-7

SK135SR		Arm: 2.84 m Bucket: Without Counterweight: 3,150 kg Shoe: 500 mm Dozer: Blade up												
B \ A		1.5 m		3.0 m		4.5 m		6.0 m		7.5 m		At max. reach		Radius
														
7.5 m	kg					*2,320	*2,320					*2,050	*2,050	4.59 m
6.0 m	kg					*2,960	*2,960	*2,080	*2,080			*1,710	*1,710	6.11 m
4.5 m	kg					*3,270	*3,270	*3,090	2,300			*1,590	*1,590	6.98 m
3.0 m	kg			*5,660	*5,660	*4,060	3,450	3,150	2,200			*1,590	1,520	7.44 m
1.5 m	kg			*7,810	5,680	4,680	3,150	3,000	2,070	*2,080	1,460	*1,660	1,430	7.58 m
G.L.	kg			*6,210	5,290	4,430	2,930	2,890	1,960			*1,850	1,450	7.40 m
-1.5 m	kg	*4,540	*4,540	*8,410	5,230	4,330	2,850	2,830	1,910			*2,210	1,590	6.88 m
-3.0 m	kg	*7,630	*7,630	*7,100	5,330	4,370	2,870					2,920	1,980	5.94 m
-4.5 m	kg			*4,370	*4,370							*2,770	*2,770	4.28 m

SK140SR _{LC}		Arm: 2.84 m Bucket: Without Counterweight: 3,150 kg + 580 kg Shoe: 500 mm Dozer: Blade up												
B \ A		1.5 m		3.0 m		4.5 m		6.0 m		7.5 m		At max. reach		Radius
														
7.5 m	kg					*2,320	*2,320					*2,050	*2,050	4.59 m
6.0 m	kg					*2,960	*2,960	*2,080	*2,080			*1,710	*1,710	6.11 m
4.5 m	kg					*3,270	*3,270	*3,090	2,560			*1,590	*1,590	6.98 m
3.0 m	kg			*5,660	*5,660	*4,060	3,820	*3,390	2,460			*1,590	*1,590	7.44 m
1.5 m	kg			*7,810	6,340	*4,960	3,520	3,630	2,330	*2,080	1,660	*1,660	1,630	7.58 m
G.L.	kg			*6,210	5,950	5,410	3,300	3,510	2,220			*1,850	1,650	7.40 m
-1.5 m	kg	*4,540	*4,540	*8,410	5,890	5,310	3,220	3,450	2,170			*2,210	1,810	6.88 m
-3.0 m	kg	*7,630	*7,630	*7,100	5,990	*4,830	3,250					*3,030	2,250	5.94 m
-4.5 m	kg			*4,370	*4,370							*2,770	*2,770	4.28 m

- Do not attempt to lift or hold any load that is greater than these lift capacities at their specified lift point radius and heights. Weight of all accessories must be deducted from the above lift capacities.
- Lift capacities are based on machine standing on level, firm, and uniform ground. User must make allowance for job conditions such as soft or uneven ground, out of level conditions, side loads, sudden stopping of loads, hazardous conditions, experience of personnel, etc.
- Arm top is defined as lift point.
- The above lift capacities are in compliance with ISO 10567. They do not exceed 87% of hydraulic lift capacity or 75% of tipping load. Lift capacities marked with an asterisk (*) are limited by hydraulic capacity rather than tipping load.
- Operator should be fully acquainted with the Operator's and Maintenance Instructions before operating this machine. Rules for safe operation of equipment should be adhered to at all times.
- Lift capacities apply to only machine as originally manufactured and normally equipped by KOBELCO CONSTRUCTION MACHINERY CO., LTD.

STANDARD EQUIPMENT

ENGINE

- Engine, ISUZU 4JJ1XDRAC, Diesel engine with turbocharger and intercooler, Tier IV Final certified
- Auto Idle Stop
- Automatic engine deceleration
- Batteries (2 x 12 V - 80 Ah)
- Starting motor (24 V - 4.0 kW), 50 amp alternator
- Engine oil pan drain cock
- Double element air cleaner

CONTROL

- Working mode selector (H-mode, S-mode and ECO-mode)
- N&B piping (proportional hand controlled)
- Extra piping (proportional hand controlled)
- Quick Hitch piping

SWING SYSTEM & TRAVEL SYSTEM

- Swing rebound prevention system
- Straight propel system
- Two-speed travel with automatic shift down
- Sealed & lubricated track links
- 500 mm steel shoes
- Grease-type track adjusters
- Automatic swing brake

MIRRORS, LIGHTS & CAMERAS

- Left side rear view mirror, rear view camera, right and left side view camera
- Three front working lights (LED)

CAB & CONTROL

- Two control levers, pilot-operated
- Horn, electric
- Integrated left-right slide-type control box
- LED door light (interior)
- Coat hook
- Large cup holder
- Detachable two-piece floor mat
- GRAMMER air suspension seat with heater
- Retractable seatbelt
- Headrest
- Handrails
- Intermittent windshield wiper with double-spray washer
- Skylight
- Opening top guard (ISO 10262: 1998)
- Tinted safety glass
- Pull-type front window and removable lower front window
- Easy-to-read 10-inch LCD SCREEN multi-display monitor
- Automatic air conditioner
- Emergency escape hammer
- Radio (AUX & Bluetooth)
- Hands-free telephone
- 12 V converter
- USB port
- Eagle eye view
- Travel alarm

OPTIONAL EQUIPMENT

- Various optional arms
- Wide range of shoes
- Wide range of buckets
- Front-guard protective structure (may interfere with bucket action)
- Additional counterweight (+580 kg)
- Additional counterweight (+1,000 kg)
- Cab top work LED lights (two lights)
- Mechanical suspension seat
- Rain visor (may interfere with bucket action)
- Additional track guide
- Roll sun shade
- Dozer Blade (for 500mm, 600mm, 700mm shoe)
- Multi control valve

Note: Standard and optional equipment may vary. Consult your KOBELCO dealer for specifics.

Note: This catalogue may contain attachments and optional equipment that are not available in your area. And it may contain photographs of machines with specifications that differ from those of machines sold in your areas. Please consult your nearest KOBELCO distributor for those items you require. Due to our policy of continuous product improvements all designs and specifications are subject to change without advance notice. Copyright by **KOBELCO CONSTRUCTION MACHINERY CO., LTD.** No part of this catalogue may be reproduced in any manner without notice.

KOBELCO CONSTRUCTION MACHINERY CO., LTD.

5-15, Kitashinagawa 5-chome, Shinagawa-ku, Tokyo 141-8626 JAPAN
Tel: +81 (0) 3-5789-2146 Fax: +81 (0) 3-5789-2135
<https://www.kobelcocm-global.com/>

Enquiries To: