

STANDARD EQUIPMENT

ENGINE

- Engine, HINO P11C-VC, diesel engine with turbocharger and intercooler
- Automatic engine deceleration
- Auto Idle Stop (AIS)
- Batteries (2 x 12V - 112Ah)
- Starting motor (24V - 5 kW), 60 amp alternator
- Removable clean-out screen for radiator
- Automatic engine shut-down for low engine oil pressure
- Engine oil pan drain cock
- Double element air cleaner

CONTROL

- Working mode selector (H-mode, S-mode and ECO-mode)
- Power Boost

SWING SYSTEM & TRAVEL SYSTEM

- Swing rebound prevention system
- Straight propel system
- Two-speed travel with automatic shift down
- Sealed & lubricated track links
- Grease-type track adjusters
- Automatic swing brake

HYDRAULIC

- Arm regeneration system
- Auto warm up system
- Aluminum hydraulic oil cooler

MIRRORS & LIGHTS

- Two rearview mirrors
- Three front working lights

CAB & CONTROL

- Two control levers, pilot-operated
- Tow eyes
- Horn, electric
- Integrated left-right slide-type control box
- Cab light (interior)
- Luggage tray
- Large cup holder
- Detachable two-piece floor mat
- Retractable seatbelt
- Headrest
- Handrails
- Heater and defroster
- Intermittent windshield wiper with double-spray washer
- Skylight
- Tinted safety glass
- Pull-type front window and removable lower front window
- Easy-to-read multi-display monitor
- Automatic air conditioner
- Emergency escape hammer
- Suspension seat
- Travel alarm
- Level indicator
- Pre-air cleaner
- Boom safety valve
- Arm safety valve

OPTIONAL EQUIPMENT

- Wide range of buckets
- Various optional arms
- Wide range of shoes
- Additional track guide
- Additional hydraulic circuit
- Multi-control valve
- FOPS guard

Note: Standard and optional equipment may vary. Consult your KOBELCO dealer for specifics.

Note: This catalog may contain attachments and optional equipment that are not available in your area. And it may contain photographs of machines with specifications that differ from those of machines sold in your areas. Please consult your nearest KOBELCO distributor for those items you require. Due to our policy of continuous product improvements all designs and specifications are subject to change without advance notice. Copyright by **KOBELCO CONSTRUCTION MACHINERY CO., LTD.** No part of this catalog may be reproduced in any manner without notice.

KOBELCO CONSTRUCTION MACHINERY CO., LTD.

17-1, Higashigotanda 2-chome, Shinagawa-ku, Tokyo 141-8626 JAPAN
Tel: +81 (0) 3-5789-2146 Fax: +81 (0) 3-5789-2135
www.kobelco-kenki.co.jp/english_index.html

Inquiries To:

Bulletin No. SK500LC AZN

201306000 Printed in Japan

ACERA Hydraulic Excavators
GEOSPEC

SK500 LC

- Bucket Capacity:
2.1 m³ ISO heaped
- Engine Power:
257 kW/1,850 min⁻¹ (ISO 9249)
271 kW/1,850 min⁻¹ (ISO 14396)
- Operating Weight:
48,200 kg



We Save You Fuel
Achieving a Low-Carbon Society

ENDLESS EVOLUTION

KOBELCO fuel economy just keeps getting better. The “Three E’s” concept that gave birth to the Acera Geospec series (Enhancement, Economy, Environment) has been further refined to reduce the emission of PM & NOx, minimize fuel consumption to incredible new lows, and create a new breed of hydraulic excavator on the cutting edge of performance. The SK500LC meets increasingly stringent environmental requirements while delivering revolutionary, next-generation operation. To offset the cost of reducing the machine’s environmental impact, we’ve cut running costs in quick response to modern needs. Through our endless evolution of fuel economy, we continue to create value for our customers, the KOBELCO way.



Pursuing The “Three E’s”



Enhancement

- High productivity resulting from lower fuel costs
- New environmental engine and energy-efficient hydraulic circuit improve fuel efficiency

Economy

- New ECO mode greatly reduces fuel consumption
- Low-maintenance design reduces operating costs
- High structural durability and reliability boost machine resale value

Environment

- New design achieves low vibration and low noise levels (including improvements in sound quality)

Reducing Fuel Consumption while Boosting Environmental Performance.

Kobelco engineers are constantly seeking better fuel efficiency and cleaner exhaust emissions. To that end, they've combined a newly developed engine with Kobelco's proprietary energy-efficient system. The result is a machine that opens new frontiers for environmentally responsible operation.

New, Environmentally Friendly Engine

Fuel efficiency
(ECO mode, compared with S mode on previous machines)
About **13%** reduction

The new ECO mode provides a maximum of about a 13% reduction in fuel consumption.

PM Reduction
(Compared with previous models)
About **88%** reduction

Since the adoption of new engine, PM emissions have been reduced by about 88%, and NOx emissions by about 44%.

Next-Generation Electronic Engine Control

The new electronic-control common-rail engine features high-pressure fuel injection and multiple injection with improved precision. It is fitted with an EGR cooler, and DP filter which deliver high output from optimized combustion and greatly reduce PM and NOx emissions.



PM emissions cut:

Limits creation of particulate matter (which results from incomplete combustion of fuel)

Common rail system

High-pressure injection atomizes the fuel, and injection timing is more precise, improving combustion efficiency.



VG Turbo

The variable-geometry turbocharger adjusts air intake to maximize combustion efficiency. At low engine speeds the nozzles are closed, the turbo speed increased and air intake is boosted. This helps lower fuel consumption.

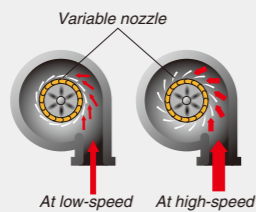

DP filter

Carbon builds up as soot on the diesel particulate filter and is burned off at high temperature. At low engine speeds the exhaust temperature is too low, and the common rail multiple injection system is then used to raise the temperature sufficiently to burn off the soot.

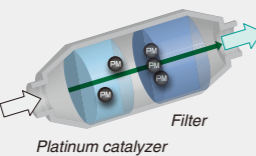

* Normally, re-circulation occurs automatically. Under certain circumstances, however, it must be done manually using a switch.

NOx emissions cut:

Reduces nitrous oxides (created by reaction with oxygen at high temperature)

EGR cooler

While ensuring sufficient oxygen for combustion, cooled emission gases are mixed with the air intake and re-circulated into the engine. The lowered oxygen temperature lowers the combustion temperature and increases combustion efficiency.

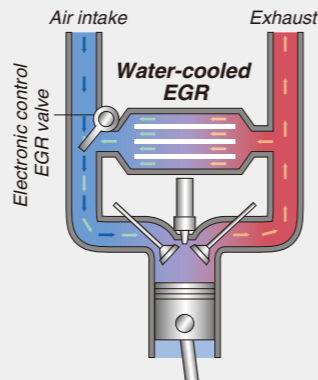

Energy-Efficient System

ECO-mode

Work modes for a closer match to the job in hand. An addition to the existing H-mode and S-mode, the new ECO-mode saves even more energy.

H-mode

For heavy duty when a higher performance level is required.

S-mode

For normal operations with lower fuel consumption.

ECO-mode

Puts priority on low fuel consumption and economic performance.

Fuel Savings in Each Mode

(Compared with previous models)



Auto Idle Stop Provided as Standard Equipment

This function saves fuel and cuts emissions by shutting down the engine automatically when the safety lock lever is pulled up. It also stops the hour meter, which helps to retain the machine's asset value.

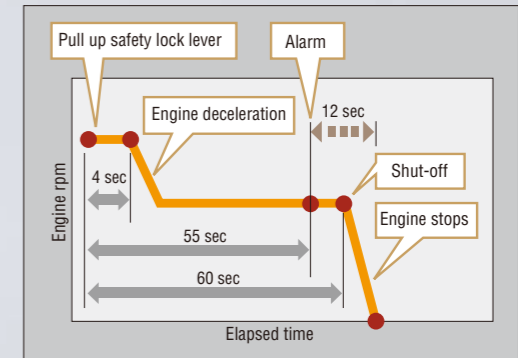

New Hydraulic System

Rigorous inspections for pressure loss are performed on all components of the hydraulic piping, from the spool of the control valve to the connectors. This regimen, combined with the use of a new, high-efficiency pump, cuts energy loss to a minimum.



Big Power, Little Fuel for Unbeatable Cost Performance.



Working Volume Per Unit Fuel
(ECO mode, compared with S mode on previous machines)
8% increase

Max. Arm Crowding Force

Normal: **203kN** {20.7tf}

With power boost: **222kN** {22.7tf}

Max. Bucket Digging Force

Normal: **267kN** {27.2tf}

With power boost: **292kN** {29.8tf}

Top-of-Class Working Ranges

Max. digging reach: **12,070mm**

Max. digging depth: **7,810mm**

Max. vertical wall digging depth: **7,120mm**

* Values are for HD arm (3.45m)



Powerful and Smooth Travel and Swing

Thanks to top-of-class travel torque, smooth travel is assured on slopes and uneven terrain, as well as when changing machine direction. Powerful swing torque also ensures smooth swing acceleration and deceleration for more efficient performance.



Multi-Display Color Monitor for Easy Checking

An LCD multi-display color monitor is fitted as standard. Operations data as well as the full range of machine-status data can readily be checked.



Analog gauge provides an intuitive reading of fuel level and engine water temperature

Green indicator light shows low fuel consumption during operation

Fuel consumption/
Switch indicator for rear camera images

Digging mode switch

Monitor display switch



One-Touch Attachment Mode Switch

A simple flick of a switch converts the hydraulic circuit and flow amount to match attachment changes. Icons help the operator to confirm the proper configuration at a glance.

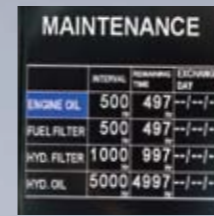

Maintenance



Fuel consumption



Rearview monitoring

Emergency Acceleration Feature

In the unlikely event of an ITCS control system malfunction, the emergency acceleration feature enables the operator to control the engine directly. The machine's backup system automatically switches to emergency operation mode.



Cab Design That Puts the Operator First



Comfort

Big Cab

The big cab provides a roomy operating space with plenty of leg-room, and the door opens wide for entry and exit. As well as giving a wide, open view to the front, the cab has increased window areas on both sides and to the rear, for improved visibility in all directions.

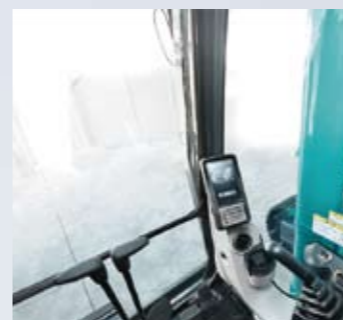

Broad View Liberates the Operator

The front window features one large piece of glass without a center pillar on the right side for a wide, unobstructed view.



Wide-Access Cab Aids Smooth Entry and Exit

Easy entry and exit assured with wider cab entry and safety lock lever integrated with mounting for control levers.

Low Vibration

Coil springs absorb small vibrations, and high suspension mounts filled with silicone oil reduce heavy vibration. The long stroke achieved by this system provides excellent protection from vibration.

Vibration control compared with previous models

- When traveling: about **30%** reduction
- When digging: about **30% to 50%** reduction

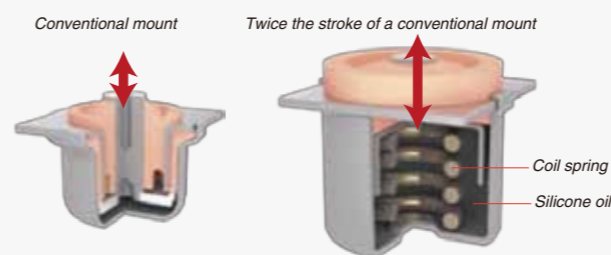

Safety

ROPS Cab

The newly developed, ROPS (Roll-Over-Protective Structure)-compliant cab clears ISO standards (ISO-12117-2: 2008) and ensures greater safety for the operator should the machine tip over.



• Level 2 FOPS Guard (ISO 10262) is available as an option

- To fit vandalism guards, please contact your KOBELCO dealer (Mounting brackets for vandalism guards)
- FOPS guard
- Wiper is stored out of sight when not in use to maintain a clear view
- Greater safety assured by rearview mirrors on left and right, and a third mirror mounted at lower right
- Tempered glass windows meet European standards



Rear view camera

A rear view camera is installed as standard to simplify checking for safety behind the machine. The picture appears on the color monitor.



Safety Features Take Various Scenarios into Consideration



• Hammer for emergency exit



• Retractable seatbelt requires no manual adjustment

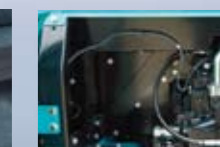

• Firewall separates the pump compartment from the engine



- Handrails meet ISO standards
- Thermal guard prevents contact with hot components during engine inspections
- Travel alarm

• Level indicator

Fast, Accurate and Low-Cost Maintenance

Monitor Display with Essential Information for Accurate Maintenance Checks



- Displays only the maintenance information that's needed, when it's needed
- Self-diagnostic function provides early-warning detection and display of electrical system malfunctions
- Record function of previous breakdowns including irregular and transient malfunction

	INTERVAL	REMAINING TIME	EXCHANGE DAY
ENGINE OIL	500	497	--/--/--
FUEL FILTER	500	497	--/--/--
HYD. FILTER	1000	997	--/--/--
HYD. OIL	5000	4997	--/--/--



Pre-air cleaner
The pre-air cleaner prolongs a replacement cycle of main air cleaner.



Comfortable "On the Ground" Maintenance

Most daily inspection and regular maintenance tasks can be easily implemented with ready access on the ground.



Double-element air cleaner
The large-capacity element features a double-filter structure that keeps the engine running clean even in dusty environments.



Pre-fuel filter (built-in water separator)
The large capacity fuel filter is designed specially for common rail engines. This high-grade filter catches 95% of all dust particles and other impurities in the fuel.



Engine oil filter



Main fuel filter

Maintenance Carried Out on Top of the Machine Is Safety-Oriented

Three steps are provided for climbing the machine, with handrails that meet ISO standards, so that maintenance can be safely carried out on top of the machine.



Handrails



Three step

More Efficient Maintenance Inside the Cab



Easy-access fuse box
More finely differentiated fuses make it easier to locate malfunctions.



DPF reactivation switch
If the monitor warning goes off, the filter should be reactivated manually using a switch.



Hour meter
Hour meter can be checked while standing on the ground.



Air conditioner filters
Internal and external air conditioner filters can be easily removed without tools for cleaning.

Easy Cleaning



Crawler frame
Special crawler frame design is easily cleaned of mud.

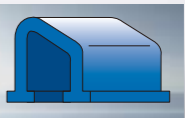

Detachable two-piece floor mat
Detachable two-piece floor mat with handles for easy removal. A floor drain is located under floor mat.

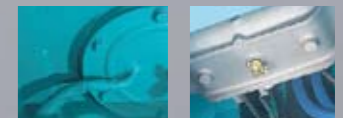

Fuel tank
Fuel tank equipped with bottom flange and large drain valve.

Long-Interval Maintenance

Long-life hydraulic oil reduces cost and labor.

Long-life hydraulic oil:
5,000 hours

Highly Durable Super-fine Filter

The high-capacity hydraulic oil filter incorporates glass fiber with superior cleaning power and durability.

Replacement cycle:
1,000 hours



Engine

Model	HINO P11C-VC
Type	Direct injection, water-cooled, 4-cycle diesel engine with turbocharger, intercooler
No. of cylinders	6
Bore and stroke	122 mm x 150 mm
Displacement	10,520 L
Rated power output	257 kW/1,850 min ⁻¹ (ISO 9249) 271 kW/1,850 min ⁻¹ (ISO 14396)
Max. torque	1,428 N·m/1,400 min ⁻¹ (ISO 9249) 1,470 N·m/1,400 min ⁻¹ (ISO 14396)

Hydraulic System

Pump	
Type	Two variable displacement pumps + one gear pump
Max. discharge flow	2 x 370 L/min, 1 x 30 L/min
Relief valve setting	
Boom, arm and bucket	31.4 MPa {320 kgf/cm ² }
Power Boost	34.3 MPa {350 kgf/cm ² }
Travel circuit	34.3 MPa {350 kgf/cm ² }
Swing circuit	25.8 MPa {000 kgf/cm ² }
Control circuit	5.0 MPa {50 kgf/cm ² }
Pilot control pump	Gear type
Main control valve	6-spool
Oil cooler	Air cooled type

Swing System

Swing motors	2 x axial piston motors
Brake	Hydraulic; locking automatically when the swing control lever is in neutral position
Parking brake	Oil disc brake, hydraulic operated automatically
Swing speed	7.8 min ⁻¹ {rpm}
Tail swing radius	3,700 mm
Min. front swing radius	5,140 mm

Attachments

Backhoe bucket and combination

Use	Backhoe bucket					
	Normal digging		Heavy digging	Normal digging		
Bucket capacity	ISO heaped	m ³	1.35	2.1	2.1	2.4
Struck		m ³	1.0	1.5	1.5	1.7
Opening width	With side cutter	mm	1,225	1,750	1,660	1,980
	Without side cutter	mm	1,100	1,630	1,580	1,860
No. of teeth			4	5	5	5
Bucket weight		kg	1,250	1,560	2,270	1,690
Combination	3.0 m short arm		○	△	△	◎
	3.45 m standard arm		○	◎	○	×
	4.9 m long arm		○	×	×	×

◎ Standard ○ Recommended △ Loading only × Not recommended

Travel System

Travel motors	2 x axial-piston, two-step motors
Travel brakes	Hydraulic brake per motor
Parking brakes	Oil disc brake per motor
Travel shoes	50 each side
Travel speed	5.4 / 3.4 km/h
Drawbar pulling force	415 kN (ISO 7464)
Gradeability	70 % {35°}

Cab & Control

Cab	
All-weather, sound-suppressed steel cab mounted on the silicon-sealed viscous suspension mounts and equipped with a heavy, insulated floor mat.	
Control	
Two hand levers and two foot pedals for travel	
Two hand levers for excavating and swing	
Electric rotary-type engine throttle	

Boom, Arm & Bucket

Boom cylinders	170 mm x 1,590 mm
Arm cylinder	190 mm x 1,970 mm
Bucket cylinder	160 mm x 1,410 mm

Refilling Capacities & Lubrications

Fuel tank	640 L
Cooling system	47.4 L
Engine oil	42.5 L
Travel reduction gear	2 x 15 L
Swing reduction gear	2 x 4.7 L
Hydraulic oil tank	283 L tank oil level 538 L hydraulic system

Working Ranges

Range	Arm	7.0 m		
		Short 3.0 m	Standard 3.45 m	Long 4.9 m
a- Max. digging reach		11.77	12.07	13.48
b- Max. digging reach at ground level		11.54	11.84	13.28
c- Max. digging depth		7.36	7.81	9.26
d- Max. digging height		11.16	10.93	11.70
e- Max. dumping clearance		7.72	7.58	8.29
f- Min. dumping clearance		3.22	2.77	1.32
g- Max. vertical wall digging depth		6.68	7.12	8.41
h- Min. swing radius		5.27	5.14	5.3
i- Horizontal digging stroke at ground level		5.21	6.10	8.28
j- Digging depth for 2.4 m (8') flat bottom		7.21	7.67	9.15
Bucket capacity ISO heaped m ³		2.1	2.1	1.35

Digging Force (ISO 6015)			
Arm length	Unit: kN (tf)		
	Short 3.0 m	Standard 3.45 m	Long 4.9 m
Bucket digging force	266 (27.1)	267 (27.2)	263 (26.8)
	291 (29.7)*	292 (29.8)*	288 (29.4)*
Arm crowding force	223 (22.8)	203 (20.7)	157 (16.0)
	244 (24.9)*	222 (22.7)*	172 (17.6)*

*Power Boost engaged.

Dimensions

Unit: mm	
Boom length	7,000
Arm length	3,450
A Overall length	12,060
B Overall height (to top of boom)	3,610
C Overall width of crawler	3,350 / 3,580**
D Overall height (to top of cab)	3,370
E Ground clearance of rear end*	1,340
F Ground clearance*	510

G Tail swing radius	3,700
G' Distance from center of swing to rear end	3,700
H Tumbler distance	4,400
I Overall length of crawler	5,450
J Track gauge	2,750
K Shoe width	600
L Overall width of upperstructure	2,980

*Without including height of shoe

**With step

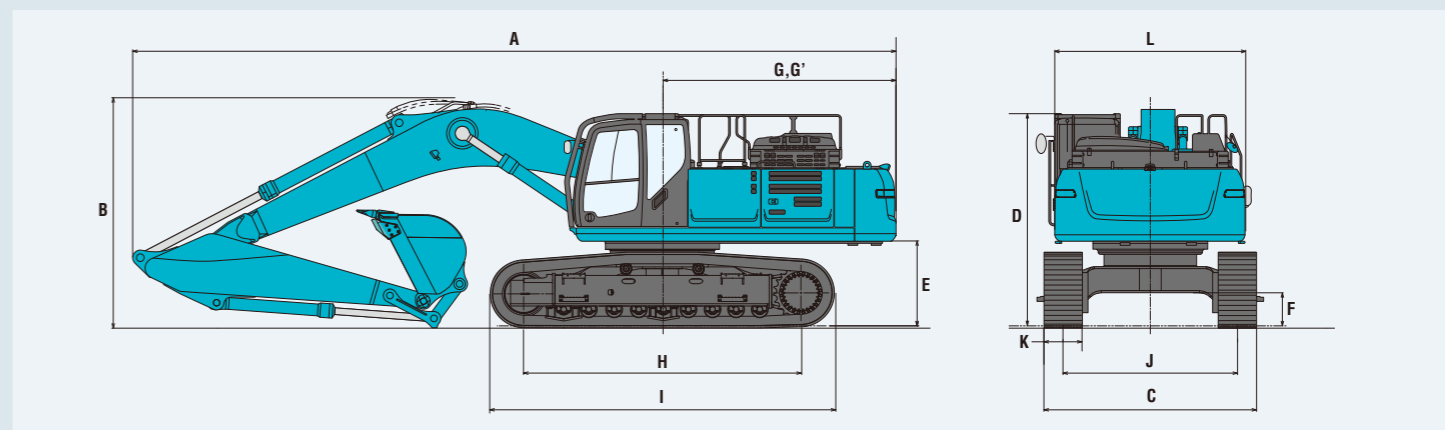

Operating Weight & Ground Pressure

In standard trim, with standard boom, 3.45 m arm, and 2.1 m³ ISO heaped bucket

Shaped		Triple grouser shoe (even height)	
Shoe width	mm	600	800
Overall width of crawler	mm	3,350	3,550
Ground pressure	kPa (kgf/cm ²)	83 (0.84)	64 (0.65)
Operating weight	kg	48,200	49,700

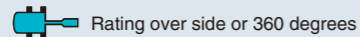
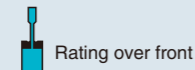
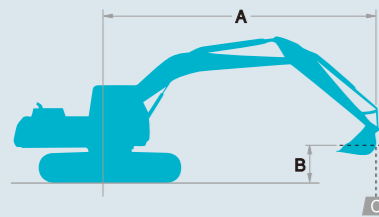

A - Reach from swing centerline to bucket hook
 B - Bucket hook height above/below ground
 C - Lifting capacities in kilograms
 • Max. discharge pressure: 31.4 MPa (320 kgf/cm²)

SK500LC		Standard Arm: 3.45 m, Bucket: 2.1 m ³ ISO heaped 1,560 kg Shoe: 600 mm																				
B	A	1.5 m		3.0 m		4.5 m		6.0 m		7.5 m		9.0 m		10.5 m		At Max. Reach		Radius				
		Rating over front	Rating over side or 360 degrees	Rating over front	Rating over side or 360 degrees	Rating over front	Rating over side or 360 degrees	Rating over front	Rating over side or 360 degrees	Rating over front	Rating over side or 360 degrees	Rating over front	Rating over side or 360 degrees	Rating over front	Rating over side or 360 degrees	Rating over front	Rating over side or 360 degrees					
7.5 m	kg																*7,080	*7,080	*6,510	*6,510	9.16 m	
6.0 m	kg																	*7,280	7,210	*6,510	6,000	9.87 m
4.5 m	kg																	*8,670	*8,670	*7,790	6,940	10.31 m
3.0 m	kg																	*17,380	*17,380	*12,300	*12,300	10.52 m
1.5 m	kg																	*20,530	18,170	*14,160	11,840	10.51 m
G.L.	kg																	*20,760	17,440	*15,380	11,250	10.28 m
-1.5 m	kg	*9,700	*9,700	*13,350	*13,350	*21,940	17,260	*15,840	10,990	*12,190	7,850	*9,820	5,950					*8,820	5,240	*7,780	4,840	9.81 m
-3.0 m	kg	*14,960	*14,960	*19,600	*19,600	*20,980	17,400	*15,510	10,980	*11,990	7,830	*9,420	5,990					*9,320	5,940	*9,320	5,940	9.07 m
-4.5 m	kg			*26,480	*26,480	*18,860	17,790	*14,170	11,210	*10,810	8,020							*9,840	7,370	*9,840	7,370	7.98 m
-6.0 m	kg					*14,930	*14,930	*11,030	*11,030									*10,190	*10,190	*10,190	*10,190	6.35 m

SK500LC		Short Arm: 3.0 m, Bucket: 2.1 m ³ ISO heaped 1,560 kg Shoe: 600 mm																				
B	A	3.0 m		4.5 m		6.0 m		7.5 m		9.0 m		At Max. Reach		Radius								
		Rating over front	Rating over side or 360 degrees	Rating over front	Rating over side or 360 degrees	Rating over front	Rating over side or 360 degrees	Rating over front	Rating over side or 360 degrees	Rating over front	Rating over side or 360 degrees	Rating over front	Rating over side or 360 degrees									
9.0 m	kg													*7,930	*7,930	7.79 m						
7.5 m	kg														*7,720	7,460	8.88 m					
6.0 m	kg														*8,300	*8,300	*7,830	7,160	*7,630	6,290	9.61 m	
4.5 m	kg														*11,030	*11,030	*9,260	*9,260	*8,280	6,920	10.06 m	
3.0 m	kg														*18,730	*18,730	*13,060	12,590	*10,380	8,930	10.28 m	
1.5 m	kg														*15,960	*15,960	*14,750	11,770	*11,400	8,450	10.27 m	
G.L.	kg														*17,860	17,480	*15,760	11,280	*12,120	8,120	10.03 m	
-1.5 m	kg	*12,400	*12,400	*21,850	17,440	*15,990	11,100	*12,360	7,960	*9,930	6,080	*9,170	5,600					*9,170	5,600	*9,170	5,600	9.55 m
-3.0 m	kg	*20,100	*20,100	*20,530	17,660	*15,380	11,160	*11,920	8,000			*9,570	6,410					*9,570	6,410	*9,570	6,410	8.78 m
-4.5 m	kg	*24,500	*24,500	*17,990	*17,990	*13,660	11,460	*10,220	8,290			*9,870	8,090					*9,870	8,090	*9,870	8,090	7.65 m
-6.0 m	kg			*13,280	*13,280							*9,660	*9,660					*9,660	*9,660	*9,660	*9,660	5.93 m

SK500LC		Long Arm: 4.9 m, Bucket: 1.35 m ³ ISO heaped 1,250 kg Shoe: 600 mm																					
B	A	1.5 m		3.0 m		4.5 m		6.0 m		7.5 m		9.0 m		10.5 m		At Max. Reach		Radius					
		Rating over front	Rating over side or 360 degrees	Rating over front	Rating over side or 360 degrees	Rating over front	Rating over side or 360 degrees	Rating over front	Rating over side or 360 degrees	Rating over front	Rating over side or 360 degrees	Rating over front	Rating over side or 360 degrees	Rating over front	Rating over side or 360 degrees	Rating over front	Rating over side or 360 degrees						
9.0 m	kg																	*4,390	*4,390	*4,390	*4,390	9.92 m	
7.5 m	kg																		*5,050	*5,050	*4,200	*4,200	10.80 m
6.0 m	kg																		*5,750	5,560	*4,150	*4,150	11.40 m
4.5 m	kg																		*6,370	*6,370	*6,080	5,360	11.79 m
3.0 m	kg																		*8,140	*8,140	*7,170	6,830	11.97 m
1.5 m	kg																		*9,110	*9,110	*17,060	*17,060	11.96 m
G.L.	kg	*3,630	*3,630	*8,720	*8,720	*19,910	17,770	*13,850	11,450	*10,650	8,130	*8,750	6,060	*7,520	4,650				*8,000	6,420	*7,060	4,860	11.76 m
-1.5 m	kg	*6,950	*6,950	*11,250	*11,250	*21,310	17,020	*15,010	10,880	*11,480	7,740	*9,300	5,810	*7,820	4,500				*8,000	6,420	*7,060	4,860	11.35 m
-3.0 m	kg	*10,540	*10,540	*15,010	*15,010	*21,530	16,780	*15,450	10,620	*11,860	7,540	*9,510	5,680	*7,760	4,460				*9,510	5,680	*7,760	4,460	10.72 m
-4.5 m	kg	*14,670	*14,670	*19,990	*19,990	*20,660	16,890	*15,100	10,620	*11,620	7,520	*9,150	5,710						*19,990	*19,990	*20,660	16,890	9.82 m
-6.0 m	kg	*19,770	*19,770	*26,960	*26,960	*18,520	17,310	*13,700	10,860	*10,410	7,730								*26,960	*26,960	*18,520	17,310	8.55 m
-7.5 m	kg			*20,340	*20,340	*14,360	*14,360	*10,430	*10,430										*20,340	*20,340	*14,360	*14,360	6.73 m

Notes:

- Do not attempt to lift or hold any load that is greater than these lift capacities at their specified lift point radius and heights. Weight of all accessories must be deducted from the above lift capacities.
- Lift capacities are based on machine standing on level, firm, and uniform ground. User must make allowance for job conditions such as soft or uneven ground, out of level conditions, side loads, sudden stopping of loads, hazardous conditions, experience of personnel, etc.
- Bucket lift hook defined as lift point.

- The above lifting capacities are in compliance with ISO 10567. They do not exceed 87% of hydraulic lifting capacity or 75% of tipping load. Lifting capacities marked with an asterisk (*) are limited by hydraulic capacity rather than tipping load.
- Operator should be fully acquainted with the Operator's and Maintenance Instructions before operating this machine. Rules for safe operation of equipment should be adhered to at all times.
- Lift capacities apply to only machine as originally manufactured and normally equipped by KOBELCO CONSTRUCTION MACHINERY CO., LTD.